

OPERATING INSTRUCTIONS & SERVICE MANUAL

AM/FM MULTIPLEX STEREO TUNER AMPLIFIER

SANSUI MODEL 1000 A

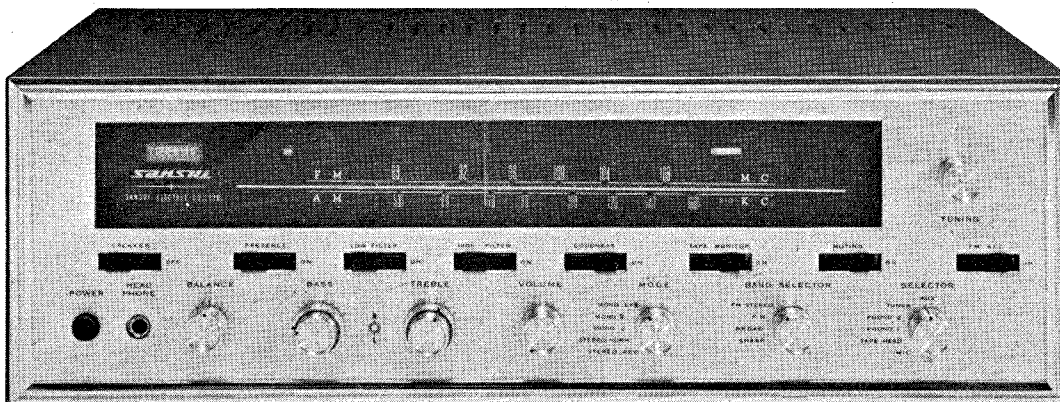

Sansui

SANSUI ELECTRIC COMPANY LIMITED

SANSUI

AM/FM MULTIPLEX STEREO TUNER AMPLIFIER

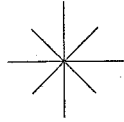

MODEL 1000A

FEATURES	4
SPECIFICATIONS	5
CHARACTERISTICS	5
CONNECTIONS	6, 7
SWITCHES AND KNOBS	8, 9
OPERATIONS	10, 11
GENERAL NOTICE	12, 13
SERVICE NOTE	14, 15, 16, 17
ALIGNMENT	18, 19
PARTS LIST	20, 21, 22, 23
PARTS LAYOUT	24
SCHEMATIC DIAGRAM	25, 26
REMOVALS DISASSEMBLE	27

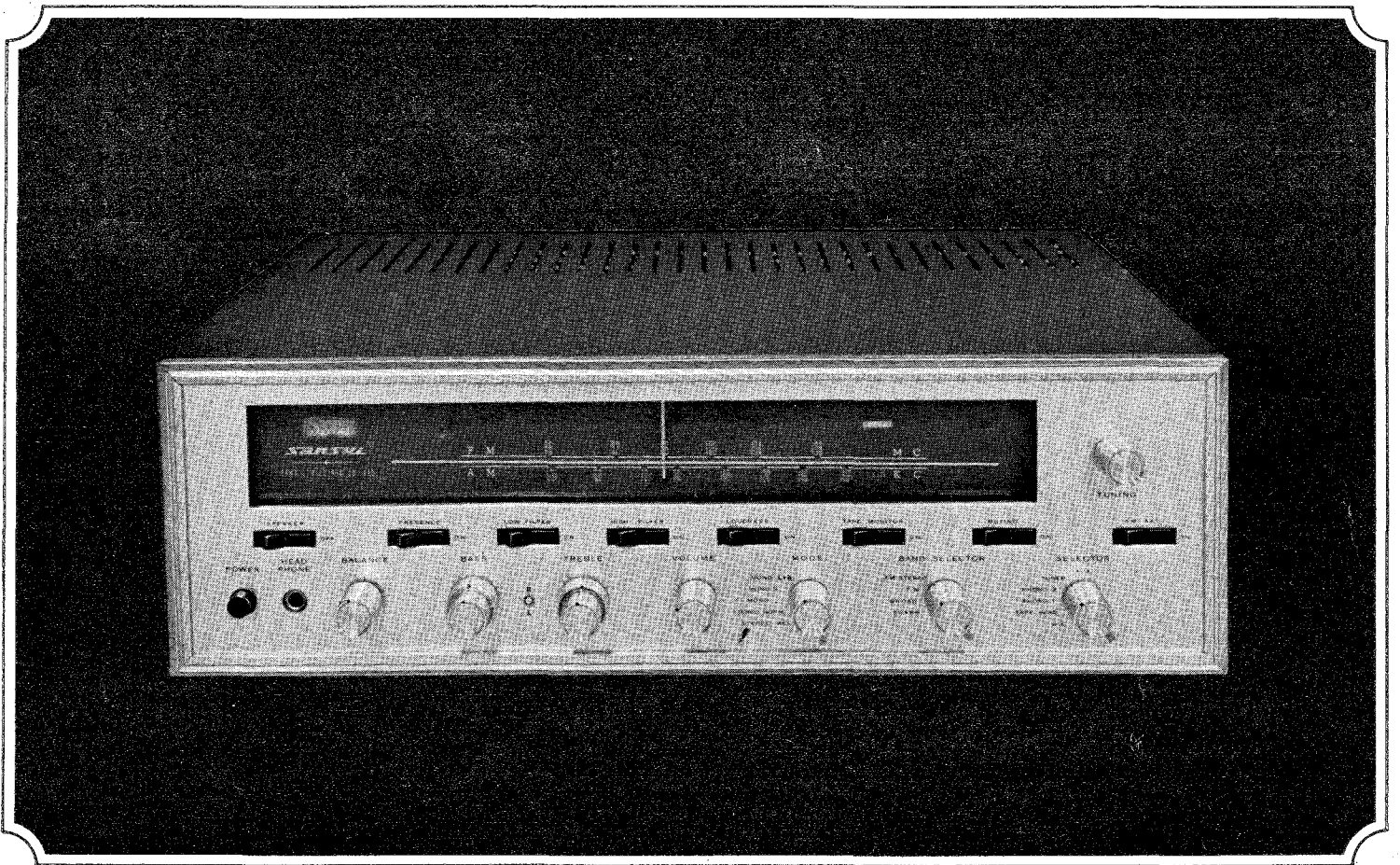

This 1000A has a music power output of 100 watts (50W-50W) and features an amazingly low distortion factor of not more than 0.8% at 76 watts. A high quality amplifier with many exciting features, it is delivered to you with Sansui's fullest confidence.

And this top quality amplifier has a super-sensitive tuner of RF amplifier consisting of two Nuvistors.

Read this instruction carefully before you use the amplifier for the first time.

MODEL 1000A CHARACTERISTICS

FEATURES SPECIFICATIONS

FEATURES

●New 7591 P. P. produces 80W without distortion (Max. 1% at 1000 cps)
The 7591 power tubes operate in class AB₁-Push-pull (fixed bias) for high fidelity reproduction. Their combined maximum output is limited to 100 Watts.
Total harmonic distortion at 1 kc is 0.8%,

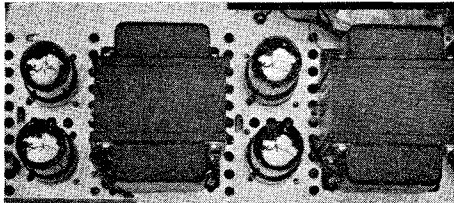

and even at very low frequency where it is extremely difficult to minimize harmonic distortion, the distortion is limited to not more than 1%. This is quite a feat for a 100 watts amplifier.

Another remarkable feature is the damping factor of 9.5, a figure which is lower than that of triode power tubes coupled in P. P. This is why bass sounds come out with such clarity.

●NFB used in all amplifier circuits, from pre-amplifier to power amplifier

The low distortion of the power amplifier is meaningless if the pre-amplifier generates distortions. This 1000A uses a three-stage amplifier circuit in its intermediate or control amplifier—unlike conventional one-stage control amplifiers—and has all its circuits in a single negative-feedback loop. These make 1000A free from noise and distortion.

●Super-precision transistor pre-amplifier eliminates hum and noise

The exclusive SANSUI four-transistor pre amplifier, which features a transistor circuit factor of 4—as compared with conventional 5~10—and a transistor noise factor of 2 db—as compared with conventional 5 db, eliminates hum and noise, the enemy of high-fidelity reproduction. The amplifier has a

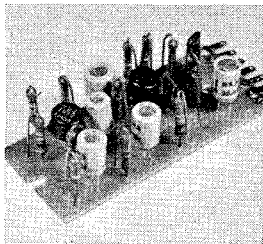

●Highly sensitive two-stage RF amplifier using two Nuvistors and a three-gang variable condenser

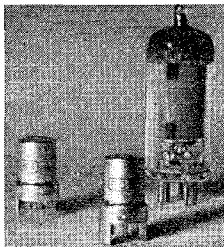

The 1000A has an extremely compact high-gain RF amplifier for FM, which uses two cascode-coupled, low noise Nuvistor tubes with a three-gang variable condenser.

Therefore the tuner outperforms conventional single-stage grounded-grid RF amplifiers by 10 db in amplification and assures stable, high-selectivity, high-fidelity reception.

●Double-limiter shuts out noise

The 1000A is equipped with a two-stage noise limiter, which works effectively even where the field intensity is weak. It reliably eliminates a wide variety of noise such as annoying ignition sounds and other interferences.

●Muting switch suppresses noise during channel selection

Unlike conventional FM receivers, which produce loud noise in the absence of input because their limiters require a certain level of

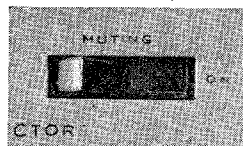

input voltage to perform their noise-limiting function, the 1000A produces no noise even when not tuned to any station. This is because it has a built-in "Muting switch"

much better S/N ratio and a gain three times larger than vacuum-tube amplifier.

(squelch circuit) which disconnects the audio amplifier stage automatically when tuner input drops below a certain level.

●Three-dimension performance possible with center-channel output terminal
The 1000A has an output terminal for the center-channel amplifier. Connect it to a monaural amplifier, and enjoy a three-dimension effect.

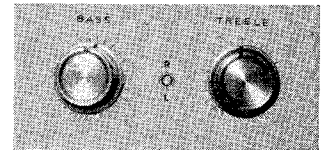
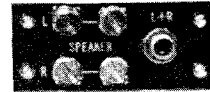

●Each channel can be operated independently (Equipped with double-knob control)
Each channel has an independent tone control for bass and treble. This makes fine adjustment possible.

●Equipped with advanced high-performance accessory circuits

This amplifier is equipped with various advanced accessory circuits such as loudness control, low and high filters, tape monitor, presence, and headphone jack.

●Amazing channel separation of 35 db and more ensured by advanced FM multiplex circuit

The adoption of the most advanced switching

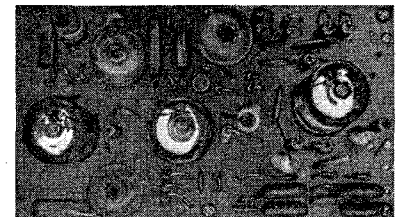

matrix method for the multiplex circuit has amazingly improved the performance of the 1000A. The amplifier has a full-fledged AFC, which can be switched off if you like.

CHARACTERISTICS



The AFC enables you to enjoy a stabilized reception of FM broadcast for many hours once you have tuned in.

- Easy-to-see FM multiplex stereo indicator



The FM multiplex stereo indicator actuated helps you tune in FM stereo stations easily and reliably.

- Single-stage RF amplifier with three-gang variable condenser for AM
The addition of a single-stage RF amplifier to the AM tuner has improved its sensitivity remarkably. This makes it particularly useful for DX reception. Moreover, it has such an excellent image ratio that no beat is produced between your station and another neighboring station.

- Built-in, high-sensitivity ferrite antenna
The built-in, high-sensitivity ferrite antenna adds to your listening pleasure by reducing noise to less than that of conventional tuners.

- Features
The input terminals are used for special



connections. When you use a cartridge of less than 2mv output, employ input transformers (SANSUI'S A-604) and connect to "PHONO-1" terminals on the back of the amplifier.

TECHNICAL SPECIFICATIONS

● AUDIO SECTION

- * Power Output
Music Power: 100 watts total
RMS Power Left/Right
40/40 watts (1% harmonic distortion)
- * Harmonic Distortion
1% at 1000 cps and RMS rated power
- * Frequency Response
Over-all: 20~20,000 cps ± 1 dB
Power amplifier section: 10~80,000 cps ± 1 dB
- * Hum and Noise
High level input: 90 dB below rated output
Low level input: 70 dB below rated output
Channel Separation: 55 dB at 1 Kc (PHONO)
- * Input Sensitivity: (for rated output)
Phono 1: 0.5 mV (by using extra matching transformers)
Phono 2: 1.5 mV
Tape Head (NAB): 1.5 mV
Mic: 1.8 mV
Aux 1: 65 mV
Aux 2: 110 mV
- Damping Factor: 9.5 at 16 ohms 1000 cps
Output Impedance: 8-, 16-ohms
- * Controls and Switches
Bass controls: 26 dB total variation at 50 cps
Treble controls: 21 dB total variation at 10 kc
Loudness control
50 cps +7.5 dB, 10,000 cps +7.5 dB
Volume control at -30 dB
Low filter: -10 dB at 50 cps
High filter: -11 dB at 10,000 cps
Presence switch: 6 dB 50 cps
Mode selector switch
1. Stereo Rev. 2. Stereo Nor. 3. Mono L.
4. Mono R. 5. Mono L+R.
Selector switch
1. Mic 2. Tape head 3. Phono 1 4. Phono 2
5. Tuner 6. Aux

- * Other Special Features
Direct tape monitor. Headphone jack.
Center-channel output for connection to a third amplifier. DIN Connector.

● FM SECTION

- Frequency Range: 88~108 Mc
- * Sensitivity
1.0 μ V for 20 dB quieting at 100% mod.
1.8 μ V (IHFM Standard)
- IF-Selectivity: 200 Kc -3 dB
FM Channel Separation: 35 dB at 1000 cps
FM Distortion: less than 1%
FM Stereo Frequency Response
50~15,000 cps ± 1 dB
- * Other Special Features
Muting. Two Nuvistor cascade front end.
Meter tuning. Double limiter. FM stereo indicator
Heavy flywheel tuning. Solid state AFC

● AM SECTION

- Frequency Range: 535 Kc~1605 Kc
IF-Selectivity: 6 Kc. 12 Kc -3 dB
Sensitivity: 5 μ V (IHFM Standard)
IF Frequency 455 Kc

● TUBES, TRANSISTORS AND DIODES

- Tubes:
6CW4 $\times 2$ (Nuvistor), 6BA6(EF-93) $\times 3$, 6BE6 (EK-90) $\times 1$, 6AU6(EF-94) $\times 2$, 6AQ8(ECC-85) $\times 3$, 12AX7(ECC-83) $\times 2$, 12AU7(ECC-82) $\times 1$, 6BL8 $\times 1$, 6AN8 $\times 2$, 7591 $\times 4$
- Transistors: 2SB-381 $\times 4$
- Diodes:
OA-91 $\times 12$, MA-301 $\times 1$, SD-1B $\times 2$, TC-02P $\times 1$

● POWER REQUIREMENTS

- Power Voltage: 100, 117, 240 volts 50, 60 cps
Power Consumption: 180 VA

● DIMENSIONS

- Width 17 7/8"
- Depth 14 3/16" (Excluding rubber stand)
- Height 5 1/2" (Excluding knobs)

- WEIGHT: 44.7 lbs

MODEL 1000A

CONNECTIONS

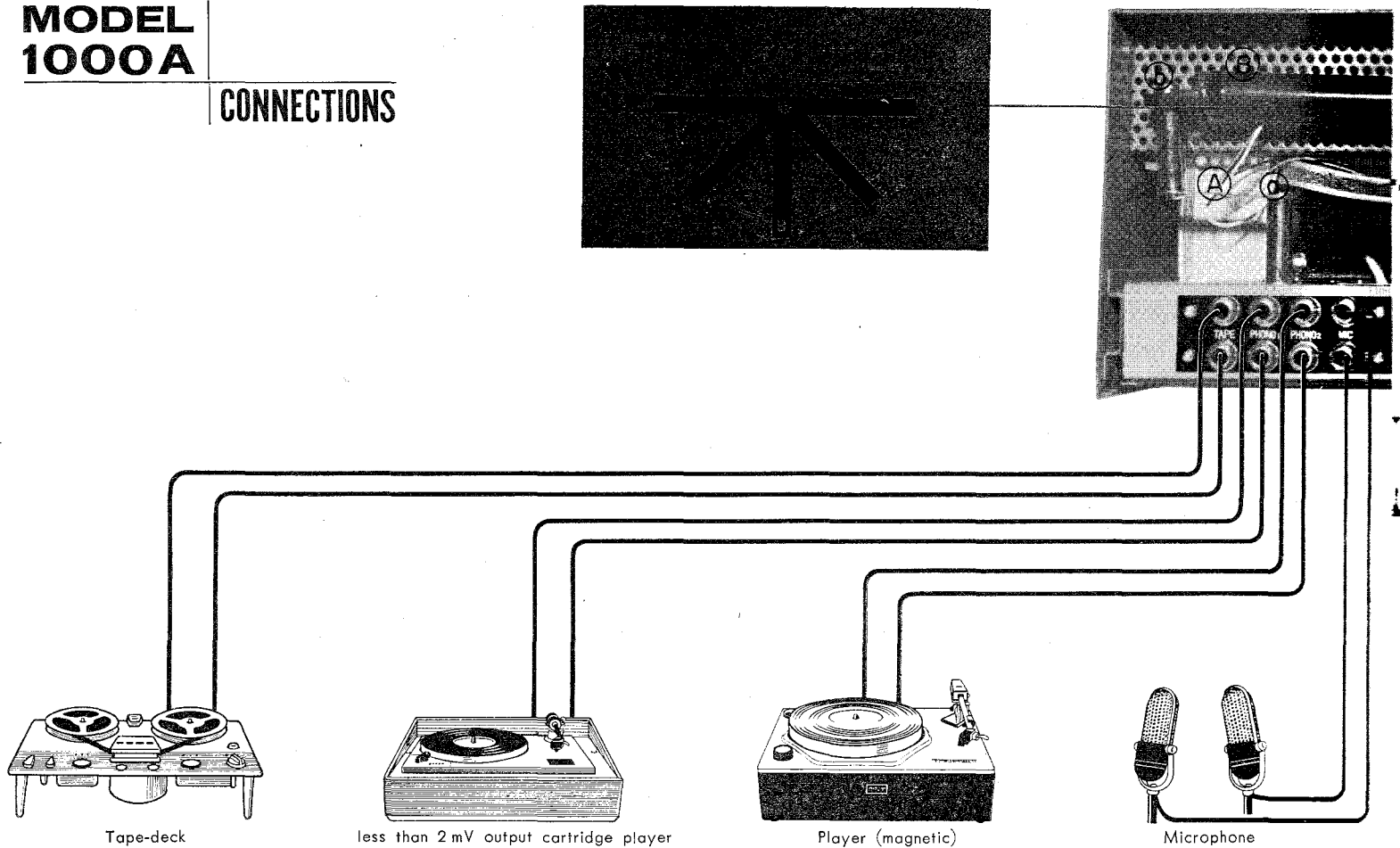

ANTENNA

Connection of FM antenna

Connect the attached FM antenna (feeders) to the A₁ and A₂ terminals.

If you live in an area near to broadcasting stations, install the antenna indoors in "T" shape, choosing its direction so that it brings in broadcasts most effectively. Be careful of the direction and height of the antenna because the input varies considerably.

When you use this amplifier in a ferro-concrete building or in an area far from the station, the signals become weak and noise stronger. In such a case, use an outdoor antenna exclusively for FM reception. FM sensitivity cannot be increased simply by lengthening the antenna wire. Adjust the height and direction of the antenna while listening to an FM program so that it ensures maximum sensitivity.

Built-in AM Antenna

To receive AM broadcasts, use the built-in ferrite antenna. As shown in the figure, pull the ferrite antenna (B) out of the amplifier by moving angle (A) on axis (a). Move (B) on axis (b) to the point where you can receive the broadcast best. This antenna will perform satisfactorily except in ferro-concrete buildings or in areas remote from broadcasting stations.

Connection of AM antenna

When you use the amplifier in a ferro-concrete building or in an area far from the station, the signals become weak and noise stronger. In such a case, use an outdoor antenna built slightly apart from the wall of your house. At the same time, ground the tuner. The direction of the antenna affects tuner sensitivity. Install it so that it can receive broadcasts most effectively. When you use an outdoor antenna, be sure to equip it with a lightning arresting switch to avoid possible danger.

RECORD PLAYER

Connect the left output of player to the "CHANNEL" on the "PHONO-1" or "PHONO-2" input terminals on the back of the amplifier.

Connect the right output of player to the "CHANNEL" on the "PHONO-1" or "PHONO-2" on the back of the amplifier.

Connect the power-cord plug receptacle of the player to the power plug on the back of the amplifier.

Either magnetic or crystal cartridge can be used with the 1000A. But, if possible, use the magnetic type for the highest fidelity. When you use the crystal type, connect to the "AUX-1" terminals. When the cartridge output voltage is less than 2 mV, employ input transformers (We recommend Type SANSUI'S A-604) in to the amplifier, and connect to "PHONO-1" terminals on the back of the amplifier. When the cartridge output voltage is over 2 mV, connect to "PHONO-2" terminals on the back of the amplifier.

* Note

A-604 in the amplifier:

Specifications of A-604

Frequency Response:

20~20,000 cps (-1 db)

Primary Impedance:

3.5Ω

Ratio: 1:40

Gain: 32 db

Weight: 43 gr

(please contact our sales shop about A-604)

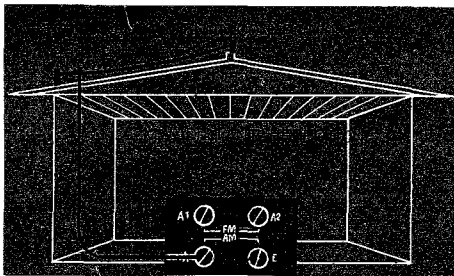
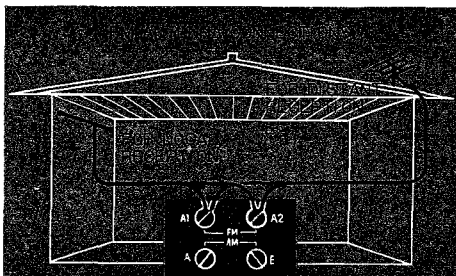
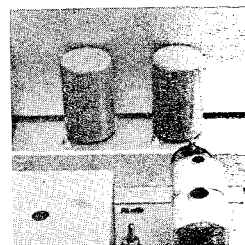

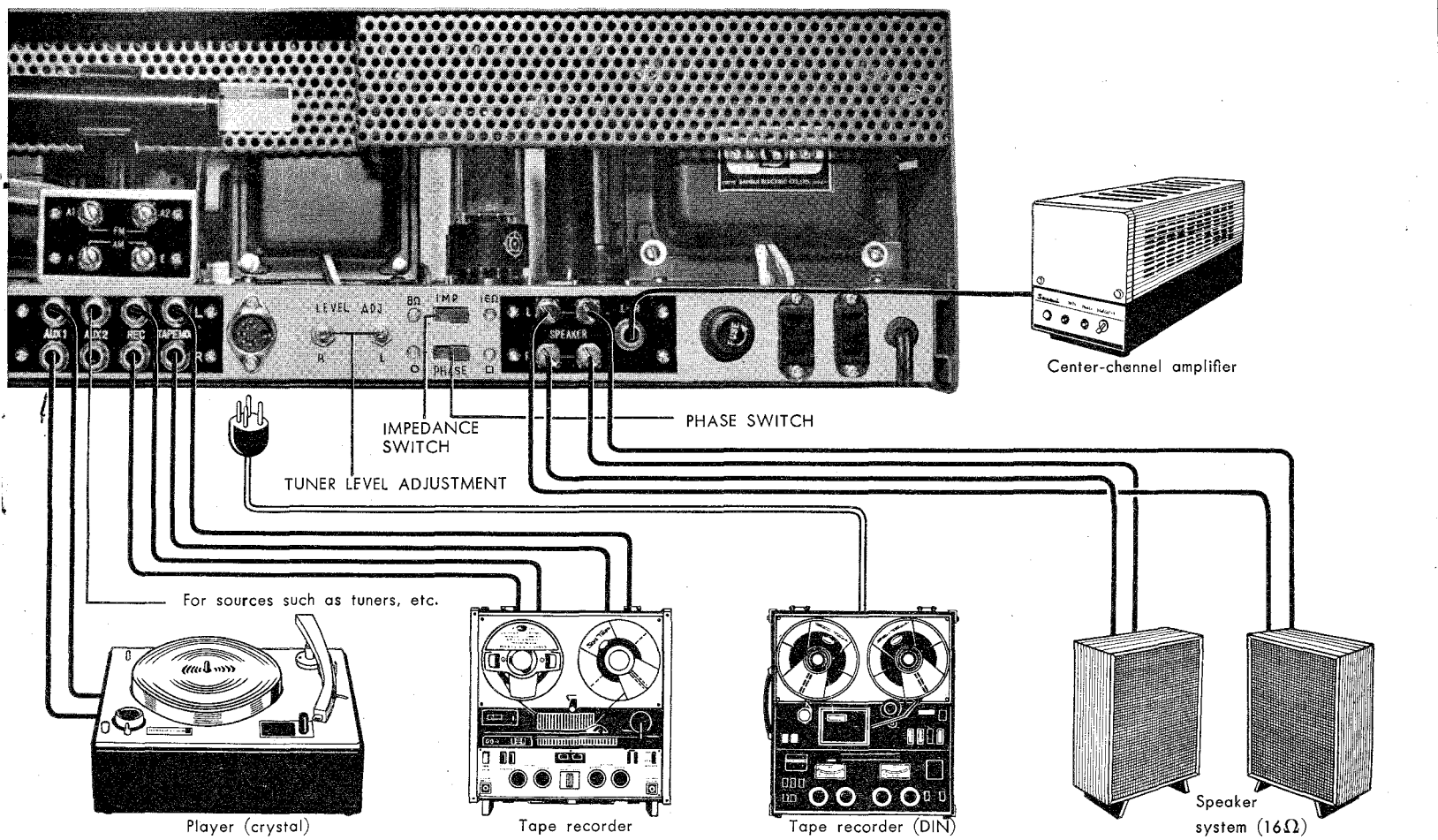

TAPE RECORDER

This amplifier can be used with a tape recorder for recording and playback and can also play tapes on the tapedeck. If you use a three-head tape recorder which has separate record and playback heads, you can make recordings while listening to a reproduction of the recordings. In other words, this amplifier can be used as a monitor which lets you know the quality of your recordings while they are being made.

1. Single-connection tape recorder

A single-connection tape recorder (DIN standard) is to be connected with the single-connection plug to the DIN socket plug on the back of the amplifier.

2. Pin-jack tape recorder

A. Recording: Connect the tape recorder input terminals to L and R (L or R in case of monaural) of the "REC" terminals on the back of the amplifier with shielded wires.

B. Play back: Connect the tape recorder output terminals ("LINE") to L and R (L or R in case of monaural operation) of the "TAPE MON" terminals on the back of the amplifier.

3. Playing tapes on the tape deck

Connect the tape deck output terminals to L and R (L or R in case of monaural operation) of the "TAPE" terminals on the back of the amplifier.

MICROPHONE

You can use a microphone with this 1000A. Any high-impedance (50-kilo-ohm) crystal, dynamic or velocity microphone is acceptable.

Connection: Connect the microphone to L or R of the "MIC" terminals on the back of the amplifier. When you use two microphones, connect one to L and the other to R.

SPEAKERS

Stereophonic reproduction

Connect the polarity of the left-hand speaker to the upper L terminals of the "Speaker" on the back of the amplifier. Connect (+)'s of the speakers to the (+) terminals. Connect the polarity of the right-hand speaker to the lower R terminals of the "Speaker" on the back of the amplifier. Connect (+)'s of the speakers to the (+) terminals. Switch the impedance switch of the amplifier in accordance with the impedance (8Ω or 16Ω) of the speakers.

* If you find that the sounds from both speakers do not mix well but leave a vacuum of sounds midway between the speakers, you can conclude that the amplifier and the speakers do not match in polarity. In such a case, reverse the phase switch in the opposite direction.

Monaural reproduction

(1) When you use one speaker system for monaural reproduction, connect the L and R speaker terminals of your amplifier as indicated

in the figure.

(2) In case an 8Ω speaker is employed, set the impedance switch at 16Ω; in case a 4Ω speaker is used, set the switch at 8Ω.

(3) Be sure to keep the phase switch at "NORMAL (O)".

Three-dimension stereophonic reproduction

This amplifier is equipped with a terminal for a center-channel amplifier so that it can be used for three-dimension reproduction. To do this, refer to the special usage shown on the page 11.

* When you use two pairs of speakers for stereophonic reproduction, make sure that the speaker output terminal connections do not touch each other and that the terminals are connected properly. If the connections are faulty, your amplifier will not work satisfactorily and may go out of order.

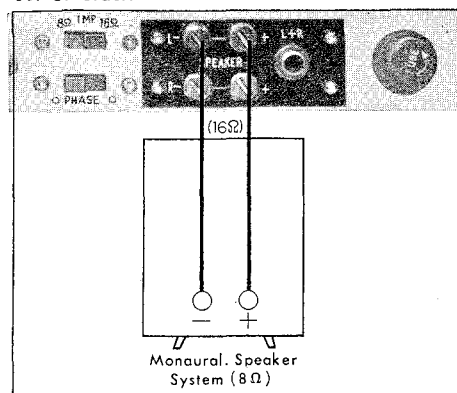

MODEL 1000A

SWITCHES AND KNOBS



① POWER

This switch is used for connecting and disconnecting the power supply. Push the button for power. Push it again to shut it off. The switch also activates and deactivates the power supply plug receptacles on the back of the amplifier.

② HEADPHONE JACK

When you want to avoid disturbing others or when you use the amplifier as a monitor, connect the headphones to this jack. You can still enjoy stereophonic reproduction through the headphones. For this purpose, you can use any kind of headphones or earphones if their plugs fit into the jack. But use dynamic headphones designed for stereophonic reproduction, if possible.

③ BALANCE

This knob is used to adjust the balance of volume between the right and left speakers for the best stereophonic effect. Make an adjustment while listening to the sounds of both speakers. When the amplifier is adjusted properly, you feel as if the sound comes from a point midway between the two speakers (in monophonic reproduction).

④ BASS AND ⑤ TREBLE FOR "L" AND "R" SPEAKERS

These control the tone of L and R speakers and each channel's bass and treble can be operated independently. Turn it clockwise for louder reproduction and to reduce turn counterclockwise. The knobs outside are the controls for the right side speakers and inside-knobs are the controls for the left side speakers.

⑥ VOLUME

Output power from the amplifier is adjusted with this control.

Do not fast turn this volume knob, or it may break small power capacity speakers.

⑦ MODE

STEREO REV: Reverses the sounds from speakers. Signals from Channels L and R are reproduced from the speaker R and L respectively.

STEREO NORM: Signals from L and R are reproduced by L and R speakers respectively. Maximum (peak) power output is 50 Watts per channel, 100 Watts total.

MONO L: Signals from L is reproduced by L and R speakers at the same time. (R input not operative) Maximum output is 100 Watts.

MONO R: Signals from R is reproduced by L and R speakers at the same time. (L input not operative) Maximum output is 100 Watts.

MONO L+R: Mixed L and R sounds from both speakers.

⑧ BAND SELECTOR

SHARP: Set the control to sharp when selectivity is preferred in listening to AM.

BROAD: When total quality is preferred in listening to AM Broadcast.

FM: For Listening to FM Broadcast.

FM STEREO: When Listening to FM Stereo broadcast.

If FM stations are near to you, listen to monaural FM broadcasts at this position. When FM stereo starts, you can enjoy it without any further functioning of the switches, provided that the MODE switch is in STEREO position.

⑨ SELECTOR

MIC: For microphone.

TAPE HEAD: For input from tape deck.

PHONO-1: For a turntable equipped with a cartridge of little output, less than 2mV. For its operation, Matching Transformers (Sansui's A-604 recommended) are required to be employed.

PHONO-2: For a turntable equipped with a standard cartridge of 2mV.

TUNER: For AM, FM radio reception.

AUX: For input from external circuit.

⑩ SPEAKER

When listening with headphones, speaker sound is eliminated by setting the speaker switch to the off position.

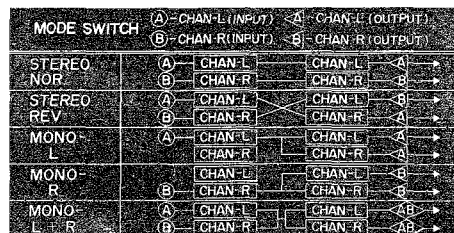



⑪ PRESENCE

If the tone control alone is used for base compensation, slightly higher frequencies are compensated at the same time. To avoid this, turn this switch "ON".

This sets the turnover at 160 cps, changing speaker damping and frequency response characteristics to compensate base. As a result, all sounds become impressive and you can enjoy clear, magnificent base.

⑫ LOW FILTER

For eliminating very low frequency noises, such as those produced by a phono turntable or a tape deck.

⑬ HIGH FILTER

For eliminating annoying noises produced by record scratch, radio "static", whistles and other interferences.

⑭ LOUDNESS

When sound volume is at a low level, you feel as if bass and treble are missing. In such a case, turn this switch "ON" to compensate bass and treble. This will make you feel as if you were present at an actual concert.

⑮ TAPE MONITOR

When switched on, sound being recorded through a three-head tape recorder can be played back through the amplifier. This switch should be on only when playing back from a tape recorder. While the tape is being recorded, it is possible

to listen to the program and monitor the recording at the same time.

When not recording, set to off.

⑯ MUTING

Turn this switch on to eliminate the noise you hear when not tuned to any station. Keep it on while tuning. However, if the muting switch is kept on when you receive weak signals, the sound may be distorted or reception may become impossible. In such a case, switch off the muting circuit.

⑰ FM-AFC

This prevents FM signals from drifting. This is likely to happen because of the very high frequencies used. If it occurs, the tonal quality deteriorates or you cannot hear the program at all. To avoid this, switch on the FM-AFC after tuning in the station of your choice. If you switch on the FM-AFC before tuning, you may not be able to tune the tuner accurately. If the FM-AFC is kept on even when there are a number of stations nearby, you may suffer from their interference. In such a case, switch off the FM-AFC.

⑱ TUNING INDICATOR

When tuning in the FM or AM station of your choice, set the dial pointer to the position where you can get a maximum indication on the tuning meter.

⑲ FM MULTIPLEX STEREO INDICATOR

When the tuner receives signals from an FM station broadcasting multiplex, this indicator lights up to show that it is receiving a stereo broadcast. The indicator never lights when the tuner is receiving a monaural FM broadcast. It lights up when the tuner is switched on, but goes off before long.

⑳ STEREO & MONO INDICATOR

Indicates Stereo and Mono reception.

㉑ DIAL SCALE

㉒ TUNING

For tuning FM and AM broadcasts, rotate the tuning knob to select desired station on FM or AM dial scale while observing the tuning indicator for the point of best reception.

RECORD PLAYER OPERATION

1. Set the "SELECTOR" switch at "PHONO-1" or "PHONO-2".
2. Set the "MODE" switch at "STEREO-NORM" or "STEREO-REV" (at L or R in case of monaural operation).
3. Switch on the player, put on a record and adjust the number of revolutions as necessary before placing the pickup on the record.
4. Balance the sound from both speakers by means of the "BALANCE" knob.
5. Adjust the amount of sound by means of the "VOLUME" knob. Other adjusting knobs and switches can be used to get the most satisfactory reproduction.

* When you play a monaural record on a stereo record player, follow the same procedure as for stereo records. This will give you better results.

* If you feel that left and right are reversed when playing a stereo record, turn the "MODE" switch to "STEREO-REV".

* To balance the sounds from both speakers, play a monaural record in the same way as a stereo record and adjust the "BALANCE" knob in such a way that you feel the sound comes from a point midway between the right and left speakers.

TAPE RECORDER OPERATION

Recording

1. Set the "SELECTOR" switch at the proper position according to the program source (broadcast or record) you are going to record.
2. Set the "MODE" switch at "STEREO-NORM" or "STEREO-REV" (for stereophonic recording), "MONO-L" or "MONO-R" (for monaural recording), or at MONO-L+R. (for monaural recording of a stereophonic source).
3. Prepare a tape recorder for recording.
4. Operate the recorder and amplifier adjusting knobs and switches properly.

Playback

1. a. Tape deck
Set the "SELECTOR" switch at "TAPE".
b. Tape recorder
Set the "TAPE MON" switch at "ON".
2. Set the "MODE" switch at "STEREO-NORM" or "REV" (for stereo), at "MONO-L" or "R" (for monaural), or at MONO-L+R (for double track monaural).
3. Set the tape recorder in the Play position.
4. Other adjusting knobs and switches should be set for the most satisfactory reproduction.

Tape Monitoring

To use your amplifier as a monitor for a three-head tape recorder, follow the same procedure as the one for playing tapes on a recorder.

When you use a recorder, read the instruction manual carefully to avoid error in connection and operation. Unless you use your amplifier with a tape recorder, be sure to switch off the "TAPE MON" switch.

Connecting tape recorder can be done using either a single connection plug or by pinjacks. The single-connection plug conforms with German DIN

standard specifications. It makes it easier to connect the tape recorder to the amplifier because it has a five-pin plug for both record and playback.

MICROPHONE OPERATION

1. Set the "SELECTOR" switch at "MIC".
2. Set the "MODE" switch at "STEREO-NORM" or "STEREO-REV" (when you use only one microphone for stereophonic effect).
At "MONO-L" or "MONO-R" (When you use only one microphone for monaural reproduction), or at MONO-L+R (when you use mixing two different program sources from two microphones).
3. Other adjusting knobs and switches can be used for the most satisfactory reproduction.

This amplifier accepts only high-impedance microphones. You cannot get the best performance if you use too long microphone cord, which causes various problems and reduces treble. This amplifier has separate tone controls for right and left speakers. You will find this feature very useful when you use one microphone for music and another for voice. Further, it gives added versatility to the amplifier, particularly when you record on a tape what is picked up by microphones,

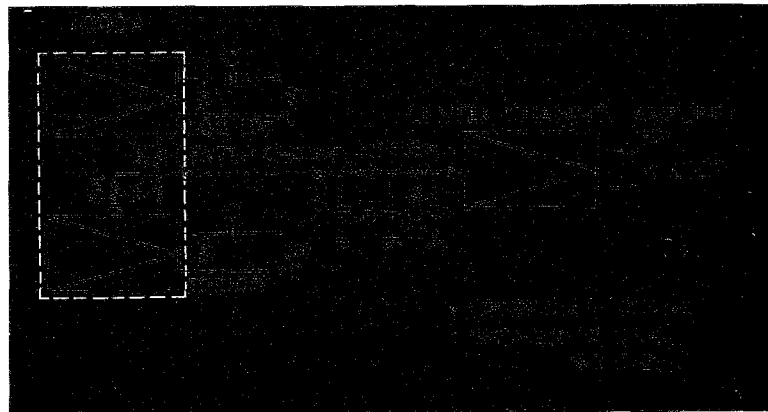

BROADCASTING RECEPTION

A. FM broadcast reception

1. Set the "SELECTOR" switch at "TUNER" (lamp lights on tuning meter).
2. Set the "BAND SELECTOR" switch at "FM".
3. You can receive at any point of the "MODE" switch.
4. FM-AFC switch at OFF.
5. Tune in the station of your choice by means of "TUNING" knob using the dial and the Tuning Meter.
6. Set the "MUTING", if noise comes out during channel selection.
7. When you have finished channel selection, switch on the "FM-AFC".
8. Use other switches and knobs according to your needs.

B. AM broadcast reception

1. Set the "SELECTOR" switch at "TUNER".
2. Set the "BAND-SELECTOR" switch at "SHARP".
3. You can receive at any point of the "MODE" switch.
4. Tune in the station of your choice by means of "TUNING" knob using the dial and the Tuning Meter.
5. Set the "BAND SELECTOR" switch at "BROAD" after the selection of a channel when you want to hear real Hi-Fi sounds.
6. Use other switches and knobs according to your needs.

C. FM MPX stereo reception

1. Set the "SELECTOR" switch at "TUNER".
2. Set the "BAND-SELECTOR" switch at "FM-MPX".
3. Set the "MODE" switch at "STEREO-NORM" or "STEREO-REV".
4. Tune in the station of your choice by means of the "TUNING" knob using the dial and the Tuning Meter.

The moment tuned in a FM stereo station, the FM Stereo Indicator lights up. It lights up immediately after the tuner has been switched on, but goes off soon.

5. The "TUNING" and "FM-AFC" switches are operated same with the FM broadcast reception.
6. Control the balance of the left and right speakers with the "BALANCE" knob.
7. Use other switches and knobs according to your needs.

FM broadcast

FM broadcasts are characterized by excellent tonal quality and freedom from noise. These features are used for compatible multiplex broadcasts. But sometimes we have to prevent the signals from FM station from drifting. This is likely to happen because of the very high frequencies used. If this occurs, the tonal quality deteriorates or you cannot hear the program at all. To avoid this, switch on the FM-AFC after tuning in the station of your choice.

FM stereo broadcast

The FM stereo broadcast has two kinds of systems for the reception. One is FCC method, and the other CROSBY (FM-FM) method. This amplifier uses the FCC method. The FCC method comprises the sum of signals from the right and left and the difference between the two. The latter serves as the code for the stereophonic effect. When signals are weak and noise is strong during stereophonic reception, the built-in noise filter or high filter is used to eliminate the high frequency noises.

AM broadcast

Set control to "SHARP" when selectivity is preferred in listening to AM broadcast. It is recommended to select the program at this position first, and then set to "BROAD". When tonal quality is preferred, set control to "BROAD". In the areas far from stations or noises and mixed signals alive, you better turn to "SHARP" for the best reception.

SPECIAL OPERATION

●THREE-DIMENSIONAL STEREO

This 1000A amplifier has an output terminal for the center-channel amplifier.

The center-channel mixes the left and right sounds to produce the three-dimensional effect.

To do this, connect the input terminal of the center-channel amplifier (monaural amplifier) to the center-channel output terminal of 1000A at the right of the speaker terminal board with shielded wire.

Connections are as the above figure.

HOW TO ELIMINATE NOISE

●AM Broadcast Reception

Noise during AM broadcast reception can often be eliminated just by changing the position of the antenna.

In an area far from the station or in the mountains where radio waves cannot reach easily, or in a ferro-concrete building or a block of such buildings, the waves are not received well, resulting in unstable reception and much noise. In such a case, connect a vinyl covered wire provided to the AM antenna terminal and stretch it along a pillar, lintel or ceiling in such a way that the signals come in best. If this does not reduce noise or improve sensitivity, erect an antenna outside the building, slightly apart from the wall.

In addition, some noises are peculiar to a certain broadcasting frequency. These result from the nature of AM waves. In some cases, they can be eliminated by grounding the amplifier or reversing the power cord plug-receptacle connections.

●FM Broadcast Reception

Noise during FM broadcast reception can be generally attributed to either of these: insufficient antenna input or interference from other electrical appliances.

Antenna input is insufficient when the antenna is not installed properly or when the station is far away. Extend and fix the attached antenna in such a position that noise is minimized.

If this does not prove effective, erect an outdoor antenna exclusively for FM reception in such a position that you can receive the broadcast most effectively.

To prevent noise, avoid using an unnecessary long antenna wire.

FM reception is affected considerably by the conditions of transmission by stations: power and antenna efficiency. As a result, you may receive

one station quite well while having difficulty in receiving another station.

●Common to AM and FM

In an area occupied by many ferro-concrete buildings, you may notice noise which occurs at a particular time of day. This type of noise can be easily distinguished from those described above. To eliminate such noise, attach a noise arrester to the electrical appliances or to the power source of your amplifier.

●Monophonic Reception of FM Multiplex Stereo Broadcasts

When you tune to an FM multiplex program, you may notice a noise which does not accompany monaural FM broadcasts. This does not mean that your tuner is out of order. In such a case, turn on the noise filter. In some cases, you can eliminate the noise by setting the treble knob of the amplifier flat or lower.

When you receive FM multiplex stereo broadcasts monophonically—with the selector at "FM"—the sounds from both speakers mix into a monaural reproduction as if you tune to an ordinary monaural FM station. Use this method if you find too much noise when receiving an FM multiplex stereo broadcast because the waves, field intensity or input is inadequate.

GROUNDING THE AMPLIFIER

Noise can sometimes be reduced by grounding the amplifier. To do this, connect the "E" terminal on the antenna terminal board on the back of your amplifier to a copper rod or plate buried deep in the ground. Use a vinyl covered or enameled wire to make the connections.

CONNECTIONS

When you connect your amplifier to a tape recorder or tuner, be sure to use an adequately

thick shielded wire. If you use an untwisted vinyl covered wire like those used for the lights, you will suffer from hum. Furthermore, do not use a wire longer than 2 meters (about 6.5 ft.), because the longer the connecting wire is, the greater the attenuation of treble becomes. For connection to a tuner or FM adaptor, use a wire 1 to 1.5 meters (about 3.3 to 4.8 ft) long. When you use the amplifier for monaural reproduction, it is easier for operation to use the upper R terminal for connection. Be sure to set the "MODE" switch to the connected channel.

HUM AND HOWLING

When you play a record or tape, you may sometimes hear unpleasant humming or howling. This does not mean that your amplifier is defective. In most cases, humming or howling is a result of these causes:

If you place a record player on or near the speaker box, the vibrations of the speaker cabinet caused by the sound waves from the speaker are transmitted to the player and cause howling. To prevent this, keep the record player away from the speaker cabinet or put a thick cushion between the player and the cabinet.

Low, buzzing sound will also be produced if you do not use shielded wire for connection. If this is not the case, examine the connections closely. Make sure that the earth and live end are not reversed so that the motor and arm are inadequately grounded.

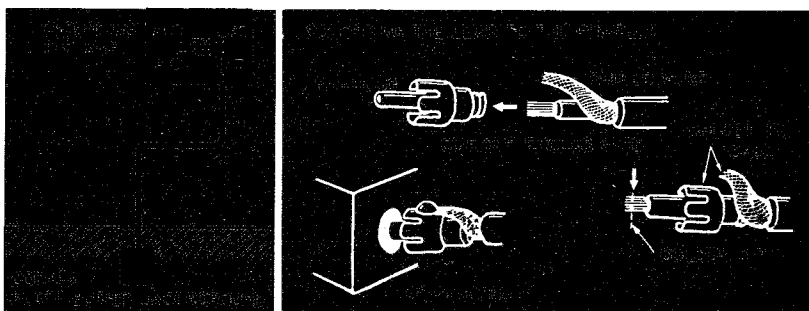

SPEAKER POLARITY

If the phase (polarity, viz. + and -) of the right and left speakers is reversed, the sounds at the center over the frequency range become weak. You will particularly sense an attenuation of bass. To make sure that speaker polarity is all right, play a monaural record on a stereo record player. If the polarity is reversed, you will have the result mentioned above. In such a case, reverse the polarity switch in the opposite position. When both speakers are thus made to agree in polarity, you will feel as if the sound is coming from a single speaker placed just between the right and left speakers.

FUSE

The amplifier does not work when the fuse is blown. In such a case, disconnect the power cord and replace the fuse on the back of the amplifier. Use a 4-ampere fuse enclosed in a glass tube. Never risk the danger of using fine wire or a fuse of a larger capacity as a substitute. If the fuse has burnt out because the amplifier is out of order, locate the trouble and repair it before replacing the fuse. The fuse blows if you use an AC plug receptacle larger than the specified capacity (30 VA).

HEAT GENERATED BY AMPLIFIER

The top of the amplifier cover becomes considerably hot after many hours of continuous operation. But this should not worry you because air vents are provided on the top and back of the cover. If you place something on the amplifier or put the amplifier in a closed box, or keep its front panel facing up, it might damage your amplifier.

When you mount this amplifier in a cabinet, it is better to take off the top cover and use a cooling fan.

CONNECT LEADWIRES PROPERLY

Connect leadwires properly to the speaker and other input and output terminals. If connections are loose or touch other parts, your amplifier will not work properly. Moreover, it may produce noise. If you use your amplifier in such a way for a long time, it may eventually break down. Finally, read the instructions for your tuner or tape recorder carefully before you connect it to your amplifier.

AC PLUG RECEPTACLES

Of the two AC plug receptacles provided on the back of the amplifier, the one nearer to the output terminals can be switched on and off by means of the power switch, while the other one cannot. These receptacles have capacities of 30 VA and 120 VA, respectively. If appliances requiring more than 150 VA are connected to these receptacles, the amplifier fuse will blow off or cause other trouble. Be sure not to overload these receptacles.

	Symptoms (1)	Symptoms (2)	Likely defective places
When the Power switch is pushed, electric supply is not on.	A. Poor power switch. B. Poor power cord. C. Poor plug contact. D. Blown fuse.	(In case the fuse blows again upon fitting a new one)	Replace it. Replace it. Replace the plug or make the plug contact better. Replace it. Short-circuit rearing in the power transformer (T ₁₀) or short-circuit of path condenser (C ₁₄₉)
When the power switch is pushed, electric supply is on.	A. The amplifier does not work at all.	1. Broken wires of vacuum tube heaters. 2. In case there is something wrong in the vacuum tube and voltage in resp. places 3. In case there is nothing wrong in the vacuum tube and voltage in resp. places	V ₁ ~V ₂₁ and silicon diodes. Check the places where there is something wrong in voltage. Check the input circuit after AUX.
	B. Only the FM tuner does not work at all.	1. Broken wires of vacuum tube heaters in the FM system. 2. In case there is something wrong in the vacuum tube and voltage in resp. places in the FM system. 3. In case there is nothing wrong in resp. places in the FM system.	V ₁ ~V ₇ , V ₁₀ Check the places where there is something wrong in voltage. Insufficient capacity of C ₄₂ , C ₄₃ . Poor IFT (T ₁ ~T ₅). Short-circuit of C ₂₅ , C ₂₆ , C ₂₇ , C ₄₄ . Trouble in the local oscillating circuit of V _{3b} (6AQ8)
	C. Only the FM-MPX system does not work.	1. Broken wires of vacuum tube heaters in the multiplex system. 2. In case there is something wrong in the vacuum tube and voltage in resp. places in the multiplex system. 3. In case there is nothing wrong in the vacuum tube and voltage in the multiplex system.	If the FM tuner works normally, check V ₁₁ ~V ₁₃ . Check the places where there is something wrong in voltage. If the FM tuner works normally, it is caused by insufficient capacity of C ₄₅ , C ₆₂ , C ₆₄ , C ₆₆ , C ₆₇ , and poor L ₁₀ , L ₁₂ , L ₁₃ .
	D. Only the AM tuner does not work	1. Broken wires of vacuum tube heaters in the AM tuner system. 2. In case there is something wrong in the vacuum tube and voltage in resp. places in the AM tuner system. 3. In case there is nothing wrong in the vacuum tube and voltage in resp. places in the AM tuner system.	V ₈ , V ₉ , V ₅ Check the places where there is something wrong in voltage. Poor IFT (T ₆ , T ₇) and RF coil (L ₅). Poor diode (OA-91). Short-circuit of C ₁₈ and C ₂₀ . Insufficient capacity of C ₃₉ .
	E. The phono, tape head and mike systems do not work.	1. In case of poor TR head. 2. In case of poor contact of the selector switch. 3. In case there is something wrong in the input circuit. 4. Poor condition of the attached appliances connected. 5. Poor coupling condenser 0.05 μF.	Replace the TR head amplifier unit. Replace it or repair the contact (S _{1a-b} S _{2a-b}) Poor contact and Short-circuit of the input terminal and pin jack. — C ₈₇ , C ₁₂₂ .
	A. In case of small sounds on resp. AUX, FM (MPX), AM tuners, phono, tape recorder, mike etc.	In case there is something wrong in voltage in power circuit and resp. places.	Check the places where there is something wrong in voltage.
	A. In case of small sounds on AUX with nothing wrong in voltage in resp. places.	1. Poor fixed resistor. 2. Short-circuit rearing in the output transformer.	Compound parts CRS-01, CRS-02, CRS-10A. T ₈ , T ₉

	Symptoms (1)	Symptoms (2)	Likely defective places
When the Power switch is pushed, electric supply is on.		3. Drop in condenser capacity and short-circuit. 4. Deterioration of vacuum tubes.	Insufficient capacity of C ₉₀ , C ₁₂₅ , C ₉₂ , C ₁₂₉ , C ₉₉ , C ₁₃₄ , C ₁₁₁ , C ₁₁₂ , C ₁₄₅ , C ₁₄₄ and tubular electrolytic condensers C ₉₁ C ₁₂₆ . V ₁₄ ~V ₂₁
	B. In case of small FM broadcasting sounds with nothing wrong in voltage in resp. places.	1. Divergence in tracking regulation. 2. Divergence in IFT regulation. 3. Poor diode. 4. Drop in Q of coils etc. 5. Poor condensers. 6. Misregulation of the semi-fixed resistors. 7. Poor contact of the rotary switch.	Refer to the regulation method of the FM tuner. Refer to the regulation method of the FM tuner. Germanium diode (OA-91) L ₁ , L ₅ , L ₆ Insufficient capacity of C ₁₁ , C ₁₄ , C ₁₆ , C ₄₁ , C ₄₃ . VR-1 VR-4 S _{2b}
	C. In case of small sounds on the FM multiplex stereo broadcasting with nothing wrong in voltage in resp. places.	1. Insufficient capacity of the coupling condensers. 2. Divergence in regulation of coils, etc. 3. Change in capacity of the condensers in the tank circuit. 4. Deterioration of diode. 5. Misregulation of the semi-fixed resistors. 6. Poor contact of the rotary switch.	C ₄₅ , C ₄₉ , C ₅₃ , C ₆₂ , C ₆₄ , C ₆₆ , C ₆₇ L ₁₀ , L ₁₂ , L ₁₃ C ₄₉ , C ₅₅ , C ₅₆ Germanium diode OA-91 VR-4, VR-5 S _{2b}
	D. In case of small AM broadcasting sounds with nothing wrong in voltage in resp. places.	1. Divergence in tracking regulation. 2. Divergence in IFT regulation. 3. Poor diode. 4. Drop in Q of coils, etc. 5. Poor condensers. 6. Misregulation of the semi-fixed resistor. 7. Poor contact of the rotary switch.	Refer to the regulation method of the AM tuner. Refer to the regulation method of the AM tuner. OA-91 L ₇ , L ₈ Insufficient capacity of C ₂₈ , C ₁₆ , C ₃₉ R ₃₂ , R ₃₅ VR-4 S _{2b}
	E. In case of small sounds on the phono, tape recording and mike with nothing wrong in voltage in resp. places.	1. In case of poor contact of the selector switch. 2. In case there is something wrong in the input circuit. 3. Poor condition of the attached appliances connected. 4. Poor coupling condensers. 5. Insufficient capacity of emitter bypass condensers.	S _{1a} , b, e, f Poor contact of the pin jack or poor shielded wires. — C ₇₅ , C ₈₄ , C ₈₇ , C ₁₁₄ , C ₁₁₅ , C ₁₁₂ C ₈₃ , C ₈₅ , C ₁₁₆ , C ₁₂₀
	A. In case the sounds from the AUX terminal are distorted much.	1. Deterioration of vacuum tubes. 2. Partial short-circuit rearing in the output transformer. 3. Poor speaker. 4. Distortion resulted from the attached appliances connected.	V ₁₅ , V ₁₉ T ₈ , T ₉ — —

	Symptoms (1)	Symptoms (2)	Likely defective places
When the Power switch is pushed, electric supply is not on.	A. Poor power switch. B. Poor power cord. C. Poor plug contact. D. Blown fuse.	(In case the fuse blows again upon fitting a new one)	Replace it. Replace it. Replace the plug or make the plug contact better. Replace it. Short-circuit rearing in the power transformer (T ₁₀) or short-circuit of path condenser (C ₁₄₉)
When the power switch is pushed, electric supply is on.	A. The amplifier does not work at all.	1. Broken wires of vacuum tube heaters. 2. In case there is something wrong in the vacuum tube and voltage in resp. places 3. In case there is nothing wrong in the vacuum tube and voltage in resp. places	V ₁ ~V ₂₁ and silicon diodes. Check the places where there is something wrong in voltage. Check the input circuit after AUX.
	B. Only the FM tuner does not work at all.	1. Broken wires of vacuum tube heaters in the FM system. 2. In case there is something wrong in the vacuum tube and voltage in resp. places in the FM system. 3. In case there is nothing wrong in resp. places in the FM system.	V ₁ ~V ₇ , V ₁₀ Check the places where there is something wrong in voltage. Insufficient capacity of C ₄₂ , C ₄₃ . Poor IFT (T ₁ ~T ₅). Short-circuit of C ₂₅ , C ₂₆ , C ₂₇ , C ₄₄ . Trouble in the local oscillating circuit of V _{3b} (6AQ8)
	C. Only the FM-MPX system does not work.	1. Broken wires of vacuum tube heaters in the multiplex system. 2. In case there is something wrong in the vacuum tube and voltage in resp. places in the multiplex system. 3. In case there is nothing wrong in the vacuum tube and voltage in the multiplex system.	If the FM tuner works normally, check V ₁₁ ~V ₁₃ . Check the places where there is something wrong in voltage. If the FM tuner works normally, it is caused by insufficient capacity of C ₄₅ , C ₆₂ , C ₆₄ , C ₆₆ , C ₆₇ , and poor L ₁₀ , L ₁₂ , L ₁₃ .
	D. Only the AM tuner does not work	1. Broken wires of vacuum tube heaters in the AM tuner system. 2. In case there is something wrong in the vacuum tube and voltage in resp. places in the AM tuner system. 3. In case there is nothing wrong in the vacuum tube and voltage in resp. places in the AM tuner system.	V ₈ , V ₉ , V ₅ Check the places where there is something wrong in voltage. Poor IFT (T ₆ , T ₇) and RF coil (L ₈). Poor diode (OA-91). Short-circuit of C ₁₈ and C ₂₀ . Insufficient capacity of C ₃₉ .
	E. The phono, tape head and mike systems do not work.	1. In case of poor TR head. 2. In case of poor contact of the selector switch. 3. In case there is something wrong in the input circuit. 4. Poor condition of the attached appliances connected. 5. Poor coupling condenser 0.05 μF.	Replace the TR head amplifier unit. Replace it or repair the contact (S _{1a-b} S _{2a-b}) Poor contact and Short-circuit of the input terminal and pin jack. — C ₈₇ , C ₁₂₂ .
A. In case of small sounds on resp. AUX, FM (MPX), AM tuners, phono, tape recorder, mike etc.	In case there is something wrong in voltage in power circuit and resp. places.	Check the places where there is something wrong in voltage.	
A. In case of small sounds on AUX with nothing wrong in voltage in resp. places.	1. Poor fixed resistor. 2. Short-circuit rearing in the output transformer.	Compound parts CRS-01, CRS-02, CRS-10A. T ₈ , T ₉	

	Symptoms (1)	Symptoms (2)	Likely defective places
When the power switch is pushed, electric supply is on.	B. In case the FM broadcasting sounds are distorted much.	<ol style="list-style-type: none"> Poor condition and small input of the antenna. Divergence in tracking regulation. Divergence in regulation of IFT. Poor germanium diode. Insufficient capacity of the condensers in the FM tuner part. 	<p>Refer to the item, How to install the antenna in this manual.</p> <p>Refer to the regulation method of FM.</p> <p>Refer to the regulation method of FM.</p> <p>OA-91</p> <p>C₁₃, C₁₅, C₁₇, C₂₁, C₂₄, C₃₅</p>
	C. In case the sounds on the FM multiplex stereo broadcasting are distorted much.	<ol style="list-style-type: none"> Sounds distorted at FM tuner. Poor regulation of the multiplex coil. Poor germanium diode. Poor condensers. Poor fixed resistor. 	<p>Refer to the item B in Symptoms 1.</p> <p>Refer to the regulation method of the multiplex adapter.</p> <p>(OA-91)</p> <p>Poor insulation of C₆₂, C₆₄</p> <p>Broken wires of R₄₆, R₅₅, R₆₃, R₆₇</p>
	D. In case the AM broadcasting sounds are distorted much.	<ol style="list-style-type: none"> Divergence in tracking regulation. Divergence in regulation of IFT. Poor germanium diode. Insufficient capacity of condenser and short-circuit. 	<p>Refer to the regulation method of AM.</p> <p>Refer to the regulation method of AM.</p> <p>OA-91</p> <p>Insufficient capacity of C₂₉, C₃₃. Puncture of C₃₄</p>
	E. In case the sounds on the phono, tape recording and mike are distorted much.	<ol style="list-style-type: none"> In case of much distortion in the attached appliances connected. Poor tubular electrolytic condensers. 	<p>—</p> <p>Puncture of C₇₅ and C₁₁₄</p>
	A. In case of big humming at the AUX terminal.	<ol style="list-style-type: none"> Insufficient capacity of the electrolytic condensers. Inner touch of vacuum tubes. Big humming in the attached appliances connected. Poor regulation of the hum balancer. Broken wires of the NF resistors. 	<p>C₁₅₆, C₁₁₃, C₁₀₈</p> <p>V₁₄~V₂₁</p> <p>—</p> <p>VR-11, VR-12</p> <p>R₁₁₇, R₁₆₃</p>
	B. In case of big humming on the FM broadcasting.	<ol style="list-style-type: none"> Hums generated when tuned to a channel. Inner touch of vacuum tubes. 	<p>Reverse connection of the power plug or poor earthing condition of the chassis.</p> <p>V₁~V₇, V₁₀</p>
	C. In case of big humming on the FM multiplex circuit system.	<ol style="list-style-type: none"> Hums generated from the above-mentioned causes. Inner touch of vacuum tubes. 	<p>Reverse connection of the power plug or poor earthing condition of the chassis.</p> <p>V₁~V₇, V₁₀~V₁₃</p>
	D. In case of big humming on the AM broadcasting.	<ol style="list-style-type: none"> Hums generated when tuned to a channel. Inner touch of vacuum tubes. 	<p>Reverse connection of the power plug or poor earthing condition of the chassis.</p> <p>V₈, V₉, V₅</p>
	E. In case of big humming on the phono, tape recording and mike systems.	<ol style="list-style-type: none"> Poor condition of shielded wires with sound appliances and their connection. Sound appliances and the shielded wires are subjected to external induction. Residual hums of sound appliances. 	<p>Refer to the item PRECAUTIONS in this manual.</p> <p>Install them as far away as possible from the induction machines.</p> <p>—</p>

	Symptoms (1)	Symptoms (2)	Likely defective places
When the power switch is pushed, electric supply is on.	A. In case of loud noises at the AUX terminal.	<ol style="list-style-type: none"> 1. Break rearing in the fixed resistor wires and touch of parts. 2. Short-circuit rearing at the condensers and touch of parts. 3. Break rearing in the primary side of the output transformers. 4. Inner touch of vacuum tubes. 	<p>R₁₀₀, R₁₀₅, R₁₁₅, R₁₁₆, R₁₁₉, R₁₂₁, R₁₄₉, R₁₅₄, R₁₆₄, R₁₆₅, R₁₆₇, R₁₆₉</p> <p>C₁₀₆, C₁₀₉, C₁₄₁, C₁₄₂</p> <p>T₈, T₉</p> <p>V₁₄~V₂₁</p>
	B. In case of a great many noise on the FM broadcasting.	<ol style="list-style-type: none"> 1. Small input voltage and poor condition of the antenna. 2. Poor vacuum tubes (high howling) 3. Break rearing in the fixed resistor wires and touching of parts. 4. Short-circuit of condensers and touch of parts. 	<p>Refer to the item ANTENNA in this manual.</p> <p>V₁, V₂, V₃</p> <p>R₂, R₃, R₅, R₇, R₉, R₁₂, R₁₄, R₁₅, R₁₈</p> <p>C₃, C₇, C₁₃, C₁₅, C₁₇, C₂₁, C₂₄</p>
	C. In case of a great many noises on the FM multiplex stereo broadcasting.	<ol style="list-style-type: none"> 1. Noises made by the above-mentioned causes. 2. Break rearing in the multiplex coil wires. 3. Break rearing at the fixed resistors. 4. Short-circuit rearing at condensers. 5. Poor vacuum tubes. 	<p>Refer to B.</p> <p>L₁₀~L₁₃</p> <p>R₄₉, R₅₆, R₆₅, R₆₄, R₆₆, R₆₈</p> <p>C₄₅, C₄₅, C₅₂, C₅₃, C₆₂, C₆₄, C₆₆, C₆₇</p> <p>V₁₁~V₁₃</p>
	D. In case of a great many noises on the phono, tape recording and mike systems.	<ol style="list-style-type: none"> 1. Poor condition of fixed resistors and break rearing at the resistor wires. 2. Poor condensers. 3. Inner noises and poor connection of the attached appliances connected. 	<p>R₈₄~R₉₆, R₁₃₃~R₁₄₅</p> <p>C₇₅~C₈₇, C₁₁₄~C₁₂₂</p> <p>—</p>
	A. While the FM tuner is working normally.	<ol style="list-style-type: none"> 1. The tuning meter does not work at all. 2. The tuning meter works slightly. 	<p>Poor (M) and broken wire of R₂₈</p> <ul style="list-style-type: none"> • It varies depends on the intensity of the electric field resulted from regional differences. • It is caused by poor condition of FM antenna.
	B. While the AM tuner is working normally.	<ol style="list-style-type: none"> 1. The tuning meter does not work at all. 2. The tuning meter works slightly. 3. In case the zero point of the meter diverges much. 	<p>Poor (M) and broken wire of R₁₀.</p> <ul style="list-style-type: none"> • It varies depending on the intensity of the electric field resulted from regional differences. • Broken wires of R₂₉, R₃₀.
	C. The stereo indicator is not lighted at the time of FM stereo reception.	<ol style="list-style-type: none"> 1. In case the multiplex adapter does not work normally. 2. In case only the indicator does not work with the multiplex adapter working normally. 3. The indicator is kept lighting while the multiplex adapter is working normally. 	<p>Refer to the item Symptoms of respective Multiplex.</p> <p>Poor NL, broken wire of R₅₀ and poor V₁₁.</p> <p>Poor OA-91 and poor regulation of VR-2.</p>
	D. Poor separation at the time of FM stereo reception.	<ol style="list-style-type: none"> 1. In case the multiplex adapter works normally. 	<p>Poor regulation of VR-3 (Refer to the regulation method of multiplex).</p>

FM ALIGNMENT PROCEDURE

1. AFC-OFF 2. Turn tuning gang fully 3. Center carrier wave. 4. Set pointer at reference mark.

STEP	ALIGN	GENERATOR	FEED SIGNAL	OUTPUT INDICATOR	DIAL SETTING	ADJUST	ADJUST FOR
1.	IF Transformer	10.7 MC ±400 KC	V ₆ Pin 1 6AU6	oscilloscope at ①		4th IFT (T ₄) Primary & Secondary	Best IFT Wave form
		10.7 MC ±400 KC	V ₅ Pin 1 6BA6	oscilloscope at ①		3rd IFT (T ₃) Primary & Secondary	Best IFT Wave form
		10.7 MC ±400 KC	V ₄ Pin 1 6BA6	oscilloscope at ①		2nd IFT (T ₂) Primary & Secondary	Best IFT Wave form
		10.7 MC ±400 KC	Couple Sweep Signal by a round tube V ₃ 6AQ8	oscilloscope at ①		1st IFT (T ₁) Primary & Secondary	Best IFT Wave form
2.	Discrimi- nator	10.7 MC ±400 KC	Couple Sweep Signal by a round tube V ₃ 6AQ8	oscilloscope at ②		5th IFT (T ₅) Discriminator Transformer	S Curve
3.	OSC.	88 MC 400 c/s 100% Modulation	Antenna Terminals	oscilloscope & V.T, V.M. at oscillo load	88 MC	OSC. coil L ₆	Maximum
4.	OSC.	108 MC 400 c/s 100% Modulation	Antenna Terminals	oscilloscope & V.T, V.M. at oscillo load	108 MC	OSC. Trimmer TC ₃	Maximum
5.		Reiterate 3, 4					
6.	RF Amp.	88 MC 400 c/s 100% Modulation	Antenna Terminals	oscilloscope & V.T, V.M. at oscillo load	88 MC	RF Amp. coil L ₅	Maximum
7.	Antenna circuit	88 MC 400 c/s 100% Modulation	Antenna Terminals	oscilloscope & V.T, V.M. at oscillo load	88 MC	Antenna coil L ₁	Maximum
8.	RF Amp	104 MC 400 c/s 100% Modulation	Antenna Terminals	oscilloscope & V.T, V.M. at oscillo load	104 MC	RF. Amp Trimmer TC ₂	Maximum
9.	Antenna circuit	104 MC 400 c/s 100% Modulation	Antenna Terminals	oscilloscope & V.T, V.M. at oscillo load	104 MC	Antenna circuit Trimmer TC ₁	Maximum
10.		Reiterate 6, 7, 8, 9					

STEP	ALIGN	GENERATOR	FEED SIGNAL	OUTPUT INDICATOR	DIAL SETTING	ADJUST	ADJUST FOR
1.	IF Transformer	455 KC ± 30 KC sweep-generator	Pin 7 6BE6	Sweep input at ③		1st I.F.T. - (T ₆) Primary & Secondary 2nd I.F.T. - (T ₇) Primary & Secondary	Best I.F.T Wave form
2.	OSC.	AM-OSCILLATOR 535 KC 400 c/s 30% Modulation	Antenna Terminals	oscilloscope & V.T, V.M. at output load	535 KC	OSC. coil L ₉	Maximum
3.	OSC.	1605 KC 400 c/s 30% Modulation	Antenna Terminals	oscilloscope & V.T, V.M. at output load	1605 KC	OSC. Trimmer TC ₆	Maximum
4.		Reiterate 2, 3,					
5.	RF Amp.	600 KC 400 c/s 30% Modulation	Antenna Terminals	oscilloscope & V.T, V.M. at output load	600 KC	RF coil L ₈	Maximum
6.	RF Amp.	140 KC 400 c/s 30% Modulation	Antenna Terminals	oscilloscope & V.T, V.M. at output load	1400 KC	RF Trimmer TC ₅	Maximum
7.		Reiterate 5, 6,					
8.	Antenna circuit	600 KC 400 c/s 30% Modulation	Antenna Terminals	oscilloscope & V.T, V.M. at output load	600 KC	Ferrite Loop Antenna at coil L ₇	Maximum
9.	Antenna	1400 KC 400 c/s 30% Modulation		oscilloscope & V.T, V.M. at output load	1400 KC	Antenna circuit at Trimmer TC-4	Maximum
10.		Reiterate 8, 9.					

1. Do not attempt to align the Multiplex Circuit unless
the following equipment is available :

- | | | |
|-------------------------------|------------------------|---------------------|
| a. Multiplex Stereo Generator | b. FM Signal Generator | c. Oscilloscope |
| d. Sweep Generator | e. AC V.T, V.M. | f. Audio oscillator |

STEP	ALIGN	GENERATOR	FEED SIGNAL	OUTPUT INDICATOR	ADJUST	ADJUST FOR
1.	67 KC Trap	67 KC Audio Signal	Connect to T.P ④	V.T, V.M. at T.P ⑤	L ₁₁	Minimum
2.	19 KC coil Transformer	FM Signal Gen. Modulated 30% by Stereo Gen. sub-Channel	Antenna Terminals Tune to signal	V.T, V.M. & Oscilloscope at output load	L ₁₀	Maximum
3.	19 KC coil	Same	Same	Same	L ₁₂	Maximum
4.	38 KC Doubler	Same	Same	Same	L ₁₈	Maximum
5.	Separation VR	FM Signal Gen. Modulated 30% by Stereo Signal Gen. Channel-L	Same	V.T, V.M. & Oscilloscope at output load Channel-R	Separation VR ₈	Channel-R Minimum

MODEL 1000A

PARTS LIST

Part No.	Nomenclature					
R1	47 K Ω	1/4 Watt	10%	Carbon	Fixed	Resistor
R2	1.5 K Ω	1/2 Watt	10%	Carbon	Fixed	Resistor
R3	3.3 K Ω	1/2 Watt	10%	Carbon	Fixed	Resistor
R4	68 Ω	1/4 Watt	10%	Carbon	Fixed	Resistor
R5	1 K Ω	1/4 Watt	10%	Carbon	Fixed	Resistor
R6	1.5 K Ω	1/2 Watt	10%	Carbon	Fixed	Resistor
R7	1 K Ω	1/4 Watt	10%	Carbon	Fixed	Resistor
R8	68 Ω	1/4 Watt	10%	Carbon	Fixed	Resistor
R9	1 K Ω	1/2 Watt	10%	Carbon	Fixed	Resistor
R10	4 K Ω	1/4 Watt	10%	Carbon	Fixed	Resistor
R11	68 Ω	1/4 Watt	10%	Carbon	Fixed	Resistor
R12	1 K Ω	1/2 Watt	10%	Carbon	Fixed	Resistor
R13	40 K Ω	1/4 Watt	10%	Carbon	Fixed	Resistor
R14	15 K Ω	1 Watt	10%	Carbon	Fixed	Resistor
R15	15 K Ω	2 Watt	10%	Carbon	Fixed	Resistor
R16	3 M Ω	1/4 Watt	10%	Carbon	Fixed	Resistor
R17	68 K Ω	1/4 Watt	10%	Carbon	Fixed	Resistor
R18	20 K Ω	1/2 Watt	10%	Carbon	Fixed	Resistor
R19	1 K Ω	1/4 Watt	10%	Carbon	Fixed	Resistor
R20	1 K Ω	1/4 Watt	10%	Carbon	Fixed	Resistor
R21	1 M Ω	1/4 Watt	10%	Carbon	Fixed	Resistor
R22	100 Ω	1/4 Watt	10%	Carbon	Fixed	Resistor
R23	20 K Ω	1/2 Watt	10%	Carbon	Fixed	Resistor
R24	20 K Ω	1/4 Watt	10%	Carbon	Fixed	Resistor
R25	50 Ω	1/4 Watt	10%	Carbon	Fixed	Resistor
R26	8 K Ω	1 Watt	10%	Carbon	Fixed	Resistor
R27	2 M Ω	1/4 Watt	10%	Carbon	Fixed	Resistor
R28	47 K Ω	1/4 Watt	10%	Carbon	Fixed	Resistor
R29	500 Ω	1/4 Watt	10%	Carbon	Fixed	Resistor
R31	10 K Ω	1/4 Watt	10%	Carbon	Fixed	Resistor
R32	100 K Ω	1/4 Watt	10%	Carbon	Fixed	Resistor
R33	2.2 M Ω	1/2 Watt	10%	Carbon	Fixed	Resistor
R34	100 K Ω	1/4 Watt	10%	Carbon	Fixed	Resistor
R35	50 K Ω	1/4 Watt	10%	Carbon	Fixed	Resistor
R36	2 M Ω	1/4 Watt	10%	Carbon	Fixed	Resistor
R37	2.2 M Ω	1/4 Watt	10%	Carbon	Fixed	Resistor
R38	220 K Ω	1/2 Watt	10%	Carbon	Fixed	Resistor
R39	500 K Ω	1/4 Watt	10%	Carbon	Fixed	Resistor
R40	50 K Ω	1/4 Watt	10%	Carbon	Fixed	Resistor
R41	7 K Ω	1/4 Watt	10%	Carbon	Fixed	Resistor
R42	1 M Ω	1/4 Watt	10%	Carbon	Fixed	Resistor
R43	50 K Ω	1/2 Watt	10%	Carbon	Fixed	Resistor
R44	82 K Ω	1/4 Watt	10%	Carbon	Fixed	Resistor
R45	1 K Ω	1/4 Watt	10%	Carbon	Fixed	Resistor
R46	510 K Ω	1/4 Watt	10%	Carbon	Fixed	Resistor
R47	4.7 K Ω	1/4 Watt	10%	Carbon	Fixed	Resistor
R48	470 Ω	1/4 Watt	10%	Carbon	Fixed	Resistor
R49	10 K Ω	1/2 Watt	10%	Carbon	Fixed	Resistor
R50	150 K Ω	1/2 Watt	10%	Carbon	Fixed	Resistor
R51	200 K Ω	1/2 Watt	10%	Carbon	Fixed	Resistor
R52	2.2 M Ω	1/4 Watt	10%	Carbon	Fixed	Resistor
R53	1 K Ω	1/4 Watt	10%	Carbon	Fixed	Resistor
R54	1 K Ω	1/4 Watt	10%	Carbon	Fixed	Resistor
R55	510 K Ω	1/4 Watt	10%	Carbon	Fixed	Resistor
R56	100 K Ω	1/2 Watt	10%	Carbon	Fixed	Resistor
R57	39 K Ω	1/4 Watt	10%	Carbon	Fixed	Resistor
R58	10 K Ω	1/4 Watt	10%	Carbon	Fixed	Resistor
R59	47 K Ω	1/4 Watt	10%	Carbon	Fixed	Resistor
R60	47 K Ω	1/4 Watt	10%	Carbon	Fixed	Resistor
R61	47 K Ω	1/4 Watt	10%	Carbon	Fixed	Resistor
R62	47 K Ω	1/4 Watt	10%	Carbon	Fixed	Resistor
R63	10 M Ω	1/2 Watt	10%	Carbon	Fixed	Resistor
R64	15 K Ω	1/2 Watt	10%	Carbon	Fixed	Resistor
R65	22 K Ω	1/2 Watt	10%	Carbon	Fixed	Resistor
R66	15 K Ω	1/2 Watt	10%	Carbon	Fixed	Resistor

Part No.	Nomenclature					
R67	10 M Ω	1/2 Watt	10%	Carbon	Fixed	Resistor
R68	22 K Ω	1/2 Watt	10%	Carbon	Fixed	Resistor
R69	8.2 K Ω	1/2 Watt	10%	Carbon	Fixed	Resistor
R70	51 K Ω	1/2 Watt	10%	Carbon	Fixed	Resistor
R71	10 K Ω	1/2 Watt	10%	Carbon	Fixed	Resistor
R72	2.2 K Ω	2 Watt	10%	Carbon	Fixed	Resistor
R73	10 K Ω	1/2 Watt	10%	Carbon	Fixed	Resistor
R74	51 K Ω	1/4 Watt	10%	Carbon	Fixed	Resistor
R75	10 K Ω	1/4 Watt	10%	Carbon	Fixed	Resistor
R76	8.2 K Ω	1/4 Watt	10%	Carbon	Fixed	Resistor
R77	100 K Ω	1/4 Watt	10%	Carbon	Fixed	Resistor
R78	100 K Ω	1/4 Watt	10%	Carbon	Fixed	Resistor
R79	800 K Ω	1/4 Watt	10%	Carbon	Fixed	Resistor
R81	150 K Ω	1/4 Watt	10%	Carbon	Fixed	Resistor
R83	150 K Ω	1/4 Watt	10%	Carbon	Fixed	Resistor
R84	100 K Ω	1/4 Watt	10%	Noise	Less	Resistor
R85	170 K Ω	1/4 Watt	10%	Noise	Less	Resistor
R86	15 K Ω	1/4 Watt	10%	Noise	Less	Resistor
R87	300 Ω	1/4 Watt	10%	Carbon	Fixed	Resistor
R88	15 K Ω	1/4 Watt	10%	Noise	Less	Resistor
R89	70 K Ω	1/4 Watt	10%	Noise	Less	Resistor
R90	15 K Ω	1/4 Watt	10%	Noise	Less	Resistor
R91	16 K Ω	1/4 Watt	10%	Carbon	Fixed	Resistor
R92	5 K Ω	1/4 Watt	10%	Carbon	Fixed	Resistor
R93	12 K Ω	1/4 Watt	10%	Carbon	Fixed	Resistor
R94	3 K Ω	1/4 Watt	10%	Noise	Less	Resistor
R95	10 Ω	1/4 Watt	10%	Carbon	Fixed	Resistor
R96	12 K Ω	1/4 Watt	10%	Noise	Less	Resistor
R97	40 K Ω	1/4 Watt	10%	Carbon	Fixed	Resistor
R98	500 K Ω	1/4 Watt	10%	Carbon	Fixed	Resistor
R99	2 K Ω	1/4 Watt	10%	Carbon	Fixed	Resistor
R100	50 K Ω	1/2 Watt	10%	Noise	Less	Resistor
R101	100 K Ω	Enclosed		in	CRSO	2
R102	15 K Ω	Enclosed		in	CRSO	2
R103	100 K Ω	Enclosed		in	CRSO	2
R104	2 K Ω	1/4 Watt	10%	Carbon	Fixed	Resistor
R105	50 K Ω	1/2 Watt	10%	Carbon	Fixed	Resistor
R106	2 M Ω	Enclosed		in	CRS-10A	
R107	2 M Ω	Enclosed		in	CRS-10A	
R108	1 M Ω	Enclosed		in	CRS-10A	
R109	50 K Ω	Enclosed		in	CRSO-1	
R110	50 K Ω	Enclosed		in	CRSO-1	
R111	50 K Ω	Enclosed		in	CRSO-1	
R112	40 K Ω	1/2 Watt	10%	Carbon	Fixed	Resistor
R113	100 Ω	1/4 Watt	10%	Carbon	Fixed	Resistor
R114	1 K Ω	1/4 Watt	10%	Carbon	Fixed	Resistor
R115	600 K Ω	1/2 Watt	10%	Carbon	Fixed	Resistor
R116	150 K Ω	1/2 Watt	10%	Carbon	Fixed	Resistor
R117	1.5 K Ω	1/4 Watt	10%	Carbon	Fixed	Resistor
R118	15 K Ω	1/4 Watt	10%	Carbon	Fixed	Resistor
R119	30 K Ω	1/2 Watt	10%	Carbon	Fixed	Resistor
R120	50 K Ω	1/2 Watt	10%	Carbon	Fixed	Resistor
R121	30 K Ω	1/2 Watt	10%	Carbon	Fixed	Resistor
R122	3 K Ω	1/4 Watt	10%	Carbon	Fixed	Resistor
R123	200 K Ω	1/4 Watt	10%	Carbon	Fixed	Resistor
R124	200 K Ω	1/4 Watt	10%	Carbon	Fixed	Resistor
R125	1 K Ω	1/4 Watt	10%	Carbon	Fixed	Resistor
R126	1 K Ω	1/4 Watt	10%	Carbon	Fixed	Resistor
R127	6 K Ω	15Watt		Wire	Wound	Resistor
R128	8 Ω	10Watt		Wire	Wound	Resistor
R129	500 Ω	1 Watt	10%	Carbon	Fixed	Resistor
R130	5 K Ω	1/4 Watt	10%	Carbon	Fixed	Resistor
R131	3 K Ω	1/4 Watt	10%	Carbon	Fixed	Resistor
R132	100 K Ω	1/4 Watt	10%	Carbon	Fixed	Resistor
R133	100 K Ω	1/4 Watt	10%	Noise	Less	Resistor

Part No.	Nomenclature							
R134	170 K Ω	1/4 Watt	10%	Noise	Less	Resistor		
R135	15 K Ω	1/4 Watt	10%	Noise	Less	Resistor		
R136	300 Ω	1/4 Watt	10%	Carbon	Fixed	Resistor		
R137	15 K Ω	1/4 Watt	10%	Noise	Less	Resistor		
R138	70 K Ω	1/4 Watt	10%	Noise	Less	Resistor		
R139	15 K Ω	1/4 Watt	10%	Noise	Less	Resistor		
R140	16 K Ω	1/4 Watt	10%	Carbon	Fixed	Resistor		
R141	5 K Ω	1/4 Watt	10%	Carbon	Fixed	Resistor		
R142	12 K Ω	1/4 Watt	10%	Carbon	Fixed	Resistor		
R143	3 K Ω	1/4 Watt	10%	Noise	Less	Resistor		
R144	10 Ω	1/4 Watt	10%	Carbon	Fixed	Resistor		
R145	12 K Ω	1/4 Watt	10%	Noise	Less	Resistor		
R146	40 K Ω	1/4 Watt	10%	Carbon	Fixed	Resistor		
R147	500 K Ω	1/4 Watt	10%	Carbon	Fixed	Resistor		
R148	2 K Ω	1/4 Watt	10%	Carbon	Fixed	Resistor		
R149	50 K Ω	1/2 Watt	10%	Noise	Less	Resistor		
R150	100 K Ω	Enclosed in CRSO-2						
R151	15 K Ω	Enclosed in CRSO-2						
R152	100 K Ω	Enclosed in CRSO-2						
R153	2 K Ω	1/4 Watt	10%	Carbon	Fixed	Resistor		
R154	50 K Ω	1/2 Watt	10%	Carbon	Fixed	Resistor		
R155	2 M Ω	Enclosed in CRSO-10A						
R156	1 M Ω	Enclosed in CRSO-10A						
R157	2 M Ω	Enclosed in CRSO-10A						
R158	50 K Ω	Enclosed in CRSO-1						
R159	50 K Ω	Enclosed in CRSO-1						
R160	50 K Ω	Enclosed in CRSO-1						
R161	100 Ω	1/4 Watt	10%	Carbon	Fixed	Resistor		
R162	1 K Ω	1/4 Watt	10%	Carbon	Fixed	Resistor		
R163	1.5 K Ω	1/4 Watt	10%	Carbon	Fixed	Resistor		
R164	600 K Ω	1/2 Watt	10%	Carbon	Fixed	Resistor		
R165	150 K Ω	1/2 Watt	10%	Carbon	Fixed	Resistor		
R166	15 K Ω	1/4 Watt	10%	Carbon	Fixed	Resistor		
R167	30 K Ω	1/2 Watt	10%	Carbon	Fixed	Resistor		
R168	3 K Ω	1/4 Watt	10%	Carbon	Fixed	Resistor		
R169	30 K Ω	1/2 Watt	10%	Carbon	Fixed	Resistor		
R170	200 K Ω	1/4 Watt	10%	Carbon	Fixed	Resistor		
R171	200 K Ω	1/4 Watt	10%	Carbon	Fixed	Resistor		
R172	1 K Ω	1/4 Watt	10%	Carbon	Fixed	Resistor		
R173	1 K Ω	1/4 Watt	10%	Carbon	Fixed	Resistor		
R174	3 K Ω	1/4 Watt	10%	Carbon	Fixed	Resistor		
R175	8 Ω	10 Watt		Wire	Wound	Resistor		
R176	500 Ω	1 Watt	10%	Carbon	Fixed	Resistor		
R177	1 Ω	2 Watt		Wire	Wound	Resistor		
R178	3 K Ω	1/4 Watt	10%	Carbon	Fixed	Resistor		
R179	600 Ω	15 Watt		Wire	Wound	Resistor		
R180	15 K Ω	1/4 Watt	10%	Carbon	Fixed	Resistor		
R181	6 K Ω	30 Watt		Wire	Wound	Resistor		
R182	2 K Ω	1/4 Watt	10%	Carbon	Fixed	Resistor		
R183	10 K Ω	1/2 Watt	10%	Carbon	Fixed	Resistor		
R184	100 K Ω	1 Watt	10%	Carbon	Fixed	Resistor		
R185	3.9 K Ω	1/4 Watt	10%	Carbon	Fixed	Resistor		
R186	10 K Ω	1/4 Watt	10%	Carbon	Fixed	Resistor		
R187	10 K Ω	1/4 Watt	10%	Carbon	Fixed	Resistor		
R188	3.3 K Ω	2 Watt	10%	Carbon	Fixed	Resistor		
R189	22 K Ω	1/4 Watt	10%	Carbon	Fixed	Resistor		
C1	10 pF	250 WV	10%			Ceramic tubular		
C2	50 pF	250 WV	10%			Ceramic tubular		
C3	0.002 μ F	250 WV	+100% -0%			Ceramic tubular		
C4	0.001 μ F	250 WV	+100% -0%			Ceramic tubular		
C5	0.001 μ F	250 WV	+100% -0%			Ceramic tubular		
C6	10 pF	250 WV	10%			Ceramic tubular		
C7	0.001 μ F	250 WV	+100% -0%			Ceramic tubular		

Part No.	Nomenclature						
C8	2 pF	250 WV	± 0.5 pF			Ceramic tubular	
C9	10 pF	250 WV	± 0.5 pF			Ceramic tubular	
C10	20 μ F	350 WV	electrolytic			Lug terminal	
C11	0.01 μ F	250 WV	+100% -0%			Ceramic tubular	
C12	0.002 μ F	250 WV	+100% -0%			Ceramic tubular	
C13	0.01 μ F	250 WV	+100% -0%			Ceramic tubular	
C14	0.01 μ F	250 WV	+100% -0%			Ceramic tubular	
C15	0.01 μ F	250 WV	+100% -0%			Ceramic tubular	
C16	0.01 μ F	250 WV	+100% -0%			Ceramic tubular	
C17	0.01 μ F	250 WV	+100% -0%			Ceramic tubular	
C18	100 pF	250 WV	10%			Ceramic tubular	
C19	50 pF	250 WV	10%			Ceramic tubular	
C20	50 pF	250 WV	10%			Ceramic tubular	
C21	0.01 μ F	250 WV	+100% -0%			Ceramic tubular	
C22	40 pF	250 WV	10%			Ceramic tubular	
C23	0.01 μ F	250 WV	+100% -0%			Ceramic tubular	
C24	0.01 μ F	250 WV	+100% -0%			Ceramic tubular	
C25	50 pF	250 WV	10%			Ceramic tubular	
C26	50 pF	250 WV	10%			Ceramic tubular	
C27	100 pF	250 WV	10%			Ceramic tubular	
C28	0.02 μ F	250 WV	+100% -0%			Ceramic tubular	
C29	0.01 μ F	250 WV	+100% -0%			Ceramic tubular	
C30	100 pF	250 WV	10%			Ceramic tubular	
C31	400 pF	500 WV	10%			Mica tubular	
C32	50 pF	250 WV	10%			Ceramic tubular	
C33	0.01 μ F	250 WV	+100% -0%			Ceramic tubular	
C34	0.05 μ F	50 WV	+100% -0%			Ceramic tubular	
C35	0.01 μ F	250 WV	+100% -0%			Ceramic tubular	
C36	20 pF	250 WV	10%			Ceramic tubular	
C37	100 pF	250 WV	10%			Ceramic tubular	
C38	3 pF	250 WV	± 0.05 pF			Ceramic tubular	
C39	0.01 μ F	400 WV	10%			Oil tubular	
C40	0.002 μ F	250 WV	+100% -0%			Ceramic tubular	
C41	0.001 μ F	250 WV	+100% -0%			Ceramic tubular	
C42	0.01 μ F	400 WV	10%			Oil tubular	
C43	0.05 μ F	400 WV	10%			Oil tubular	
C44	800 pF	400 WV	10%			Oil tubular	
C45	0.02 μ F	250 WV	+100% -0%			Ceramic tubular	
C46	0.03 μ F	50 WV	+100% -0%			Ceramic tubular	
C47	150 pF	250 WV	10%			Ceramic tubular	
C48	100 pF	250 WV	10%			Ceramic tubular	
C49	2000 pF	250 WV	5%			Mica tubular	
C50	1500 pF	250 WV	5%			Mica tubular	
C51	10 μ F	12 WV				electrolytic tubular	
C52	1 μ F	150 WV				electrolytic tubular	
C53	0.001 μ F	400 WV	10%			Oil tubular	
C54	5 μ F	25 WV				electrolytic tubular	
C55	0.01 μ F	250 WV	5%			Mica tubular	
C56	3000 pF	250 WV	5%			Mica tubular	
C57	100 pF	250 WV	10%			Ceramic tubular	
C58	100 pF	250 WV	10%			Ceramic tubular	
C59	100 pF	250 WV	10%			Ceramic tubular	
C60	100 pF	250 WV	10%			Ceramic tubular	
C61	100 pF	250 WV	10%			Ceramic tubular	
C62	0.003 μ F	250 WV	+100% -0%			Ceramic tubular	
C63	100 pF	250 WV	10%			Ceramic tubular	

MODEL 1000A

PARTS LIST

Part No.	Nomenclature			
C64	0.003 μ F	250 WV	+100% -0%	Ceramic tubular
C65	20 μ F	350 WV	electrolytic	Lug terminal
C66	0.01 μ F	400 WV	10%	Oil tubular
C67	0.01 μ F	400 WV	10%	Oil tubular
C68	82 pF	250 WV	5%	Mica tubular
C69	510 pF	250 WV	5%	Mica tubular
C70	430 pF	250 WV	5%	Mica tubular
C71	82 pF	250 WV	5%	Mica tubular
C72	20 μ F	180 WV		electrolytic tubular
C73	510 pF	250 WV	5%	Mica tubular
C74	430 pF	250 WV	5%	Mica tubular
C75	30 μ F	10 WV		electrolytic tubular
C76	450 pF	500 WV	10%	Mica tubular
C77	450 pF	500 WV	10%	Mica tubular
C78	0.01 μ F	250 WV	10%	Ceramic tubular
C79	20 μ F	25 WV	10%	electrolytic tubular
C80	0.006 μ F	250 WV	10%	mylar tubular
C81	0.025 μ F	50 WV	10%	mylar tubular
C82	0.01 μ F	50 WV	10%	mylar tubular
C83	30 μ F	10 WV		electrolytic tubular
C84	30 μ F	12 WV		electrolytic tubular
C85	30 μ F	10 WV		electrolytic tubular
C86	10 μ F	12 WV		electrolytic tubular
C87	0.05 μ F	50 WV	10%	mylar tubular
C88	100 pF	500 WV	10%	Mica tubular
C89	0.01 μ F	50 WV	10%	mylar tubular
C90	0.05 μ F	50 WV	10%	mylar tubular
C91	30 μ F	6 WV		electrolytic tubular
C92	0.02 μ F	400 WV	10%	Oil tubular
C93	150 pF	enclosed in CRSO-2		
C94	0.001 μ F	400 WV	10%	Oil tubular
C95	20 pF	250 WV	10%	Ceramic subular
C96	0.003 μ F	enclosed in CRSO-2		
C97	0.03 μ F	enclosed in CRSQ-2		
C98	20 μ F	350 WV	electrolytic	Lug terminal
C99	0.03 μ F	400 WV	10%	Oil tubular
C100	0.01 μ F	Enclosed in CRS-10A		
C101	0.005 μ F	Enclosed in CRS-10A		
C102	0.005 μ F	Enclosed in CRS-10A		
C103	300 pF	Enclosed in CRSO-1		
C104	200 pF	Enclosed in CRSO-1		
C105	200 pF	Enclosed in CRSO-1		
C106	0.2 μ F	250 WV	M. P condenser	
C107	30 μ F	6 W		Velectrolytic tubular
C108	20 μ F	350 WV	electrolytic	Lug terminal
C109	30 pF	500 WV	10%	Mica tubular
C110	0.5 μ F	250 WV	10%	M. P condenser
C111	0.3 μ F	250 WV	10%	M. P condenser
C112	0.3 μ F	250 WV	10%	M. P condenser
C113	20 μ F	500 WV	electrolytic	Lug terminal
C114	30 μ F	10 WV		electrolytic tubular
C115	30 μ F	12 WV		electrolytic tubular
C116	30 μ F	10 WV		electrolytic tubular
C117	0.01 μ F	50 WV	10%	mylar tubular
C118	0.025 μ F	50 WV	10%	mylar tubular
C119	0.006 μ F	50 WV	10%	mylar tubular
C120	30 μ F	10 WV		electrolytic tubular
C121	10 μ F	12 WV		electrolytic tubular
C122	0.05 μ F	50 WV	10%	mylar tubular
C123	100 pF	500 WV	10%	Mica tubular
C124	0.01 μ F	50 WV	10%	mylar tubular
C125	0.05 μ F	50 WV	10%	mylar tubular
C126	30 μ F	6 WV		electrolytic tubular
C127	0.001 μ F	400 WV	10%	Oil tubular
C128	150 pF	enclosed in CRSO-2		

Part No.	Nomenclature			
C129	0.02 μ F	400 WV	10%	Oil tubular
C130	20 pF	250 WV	10%	Ceramic tubular
C131	0.03 μ F	Enclosed in CRSO-2		
C132	0.003 μ F	Enclosed in CRSO-2		
C133	0.01 μ F	Enclosed in CRS-10A		
C134	0.03 μ F	400 WV	10%	Oil tubulat
C135	0.005 μ F	Enclosed in CRS-10A		
C136	0.005 μ F	Enclosed in CRS-10A		
C137	300 pF	Enclosed in CRSO-1		
C138	200 pF	Enclosed in CRSO-1		
C139	200 pF	Enclosed in CRSO-1		
C140	30 μ F	6 WV		electrolytic tubular
C141	0.2 μ F	250 WV	10%	M. P condenser
C142	30 pF	500 WV	10%	Mica tubular
C143	0.5 μ F	250 WV	10%	M. P condenser
C144	0.3 μ F	250 WV	10%	M. P condenser
C145	0.3 μ F	250 WV	10%	M. P condenser
C146	0.002 μ F	250 WV	10%	Ceramic tubular
C147	0.002 μ F	250 WV	10%	Ceramic tubular
C148	0.002 μ F	250 WV	10%	Ceramic tubular
C144	0.005 μ F	500 WV	10%	Ceramic tubular
C150	50 μ F	50 WV		electrolytic tubular
C151	0.005 μ F	600 WV	10%	Oil tubular
C152	0.005 μ F	600 WV	10%	Oil tubular
C153	200 μ F	25 WV		electrolytic tubular
C154	200 μ F	300 WV	electrolytic	Lug terminal
C155	200 μ F	300 WV	electrolytic	Lug terminal
C156	20 μ F	500 WV	electrolytic	Lug terminal
C157	20 μ F	25 WV		electrolytic tubular
C158	25 μ F	50 WV		electrolytic tubular
C159	200 μ F	25 WV		electrolytic tubular
C160	20 μ F	500 WV	electrolytic	Lug tetminal
C161	0.05 μ F	50 WV	+100% -0%	Ceramic tubular
C162	5 μ F	25 WV		electrolytic tubular
C163	0.01 μ F	250 WV	10%	Ceramic tubular
C164	0.01 μ F	250 WV	10%	Ceramic tubular
C165	20 μ F	350 WV	electrolytic	Lug terminal
C166	100 pF	250 WV	10%	Ceramic tubular
C167	0.002 μ F	250 WV	10%	Ceramic tubular
VR-1	5 K Ω (B)	Variable Resistor	Driver type	
VR-2	10v K Ω (B)	Variable Resistor	Driver type	
VR-3	100 K Ω (B)	Variable Resistor	Driver type	
VR-4	500 K Ω (B)	Variable Resistor	Driver type	
VR-5	500 K Ω (A)	Variable Resistor	24 ϕ type	
		(Roudness tup 120 K Ω)		
VR-7, VR-8	1 M Ω (N)	Variable Resistor	24 ϕ friction type	
		(Tone control)		
VR-9	500 K Ω (A. C)	Variable Resistor	24 ϕ type	
		(Balance control)		
VR-10, VR-13	10 K Ω (B)	Variable Resistor	Driver type	
VR-11, VR-12	100 Ω	HUM Balancer		
VC-1	6~18 pF	Variable Capacitor		
		(FM. RF Tuning)		
VC-2	6~18 pF	Variable Capacitor		
		(FM. RF Tuning)		
VC-3	6~18 pF	Variable Capacitor		
		(FM. oscillator)		
VC-4	8.8~328 pF	Variable Capacitor		
		(AM. RF Tuning)		
VC-5	8.8~328 pF	Variable Capacitor		
		(AM. RF Tuning)		
VC-6	8.8~328 pF	Variable Capacitor		
		(AM. oscillator)		

Part No.	Nomenclature
TC-1	15 pF trimer condenser
TC-2	15 pF trimer condenser
TC-3	10 pF trimer condenser
TC-4	15 pF trimer condenser
TC-5	15 pF trimer condenser
TC-6	15 pF trimer condenser
V1	6CW4 FM. RF. Amp
V2	6CW4 FM. RF. Amp
V3	6AQ8 (ECC 85) FM. oscillator & Mixer
V4	6BA6 (EF 93) FM. 1st. IF. Amp
V5	6BA6 (EF 93) AM. FM. 2nd IF. Amp
V6	6AU6 (EF 94) 1st Limitor
V7	6AU6 (EF 94) 2nd Limitor
V8	6BA6 (EF 93) AM. RF. Amp
V9	6BE6 (EK 90) AM. convertor
V10	6AQ8 (ECC 85) Muting Amp
V11	6AQ8 (ECC 85) MPX. Amp & Indicator Amp
V12	6BL8 (ECF 80) 19 KC synchro & doubler
V13	12AU7 (ECC 82) Dual, out & deemphasis
V14	12AX7 (ECC 83) Pre Amp
V15	6AN8, Audio, Amp, Phase, splitter
V16	7591 Power Amp
V17	7591 Power Amp
V18	12AX7 (ECC 83) Pre Amp
V19	6AN8, Audio, Amp, Phase, splitte
V20	7591 Power Amp
V21	7591 Power Amp
TR1~4	transistor 2SB-381
L1	FM. Antenna coil AFC-1
L2	FM. RF coil 1 μ H
L3	FM. RF coil 1 μ H
L4	FM. RF coil 3.5 μ H
L5	FM. Tuning coil
L6	FM. oscillator coil
L7	MW. Loop stick Antenna coil
L8	MW. RF. coil
L9	MW. oscillator coil
L10	MPX. coil MFC-5A
L11	MPX. coil MFC-5B
L12	MPX. coil MPT-4A
L13	MPX. coil MPT-4B
L14	Filter coil 1 μ H
L15	Filter coil 1 μ H
L16	Filter coil 1 μ H
L17	Heater Cralk coil
L18	Heater Cralk coil
L19	Heater Cralk coil
L20	Heater Cralk coil
T1	1st FM. I.F.T. 10.7 Mc/s
T2	2nd FM. I.F.T. 10.7 Mc/s
T3	3rd FM. I.F.T. 10.7 Mc/s
T4	4th FM. I.F.T. 10.7 Mc/s
T5	FM Discriminator transformer
T6	1st AM. I.F.T. 455 Kc/s
T7	2nd AM. I.F.T. 455 Kc/s
T8	output transformer (Primary 6 K Ω) (Secondary 8 Ω , 16 Ω)
T9	output transformer (Primary 6 K Ω) (Secondary 8 Ω , 16 Ω)
T10	Power transformer

Part No.	Nomenclature
SD-1B	Si, diode. AC (RMS) 180V, I _D 500 mA -65°C~100°C
OA-91	Ge, diode, V _D =90V I _D =50 mA -55°C~75°C
MA-301	Variable capacitor (FM. AFC)
TC. O-2P	Selenium diode AC 45V I _D 25 mA
JAC-1	Headphone Jack
JAC-2	DIN Jack (tape recorder connector)
PU-1	input trans connector
PU-2	Power Adjustment for 100V/117V/220V/240V
NL	PL-21A Neon Lamp
PL	Pilot Lamp 6.3V 0.15A Fuse type 6.3V 0.3A
F	Fuse 4A
M	Tuning Indicator
S1(a~g)	Input Selector Y-4-8-6
S2(a~g)	Band Selector Y-3-6-4
S2(a~c)	Mode Selector Y-3-4-5
SS1	FM. AFC Switch
SS2	Mutting Switch
SS3a, 3b	Tape Monitor Switch
SS4a, 4b	Loudness Switch
SS5a, 5b	Low Filter Switch
SS6a, 6b	High Filter Switch
SS7a, 7b	Presence Switch
SS8a, 8b	Speaker Switch
SS9a, 9b	Impedance Switch
SS10	Phase Switch
PS-1	Power Switch
CO-1, 2	AC, Receptacles

MODEL 1000A

PARTS LAYOUT

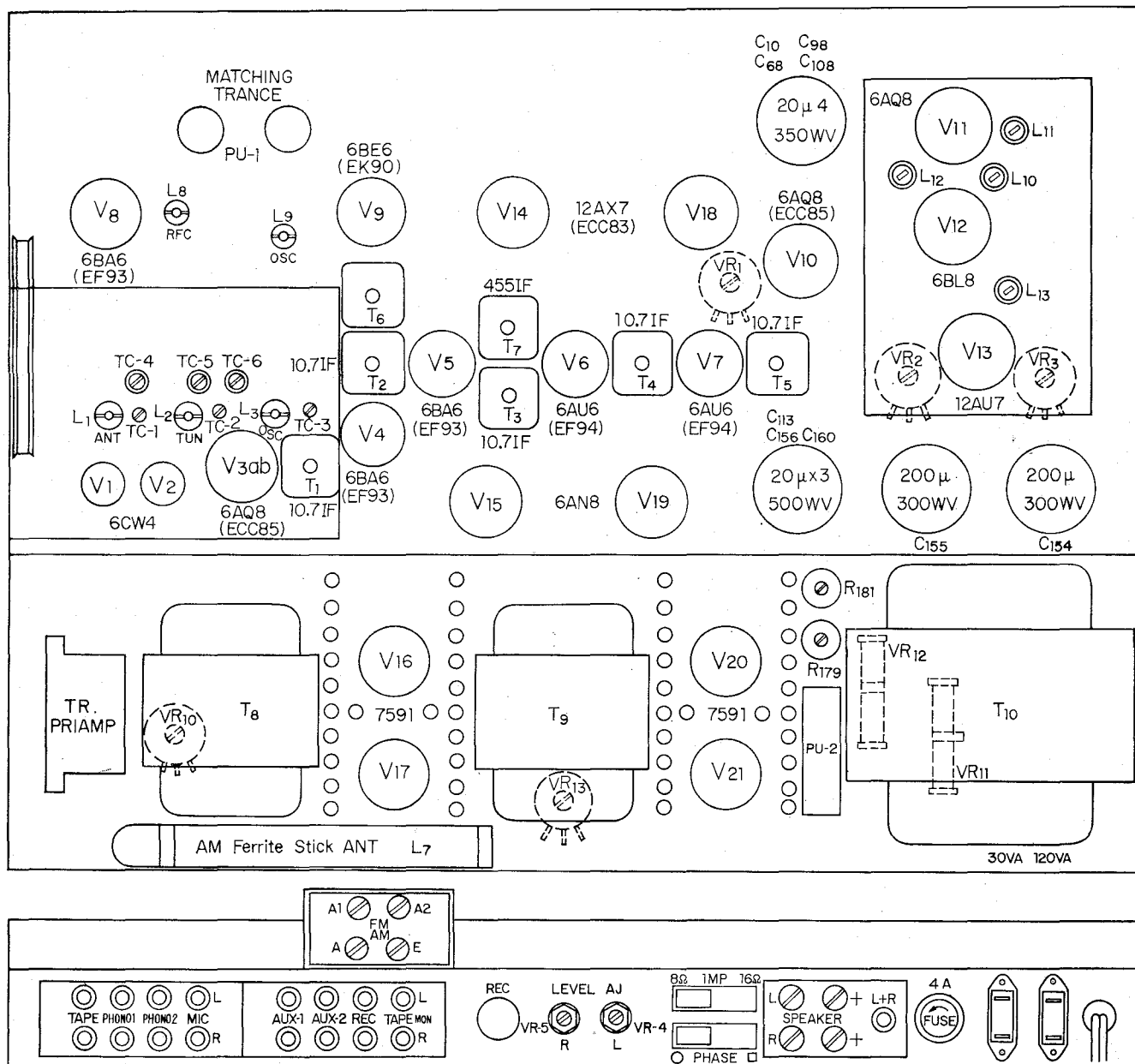

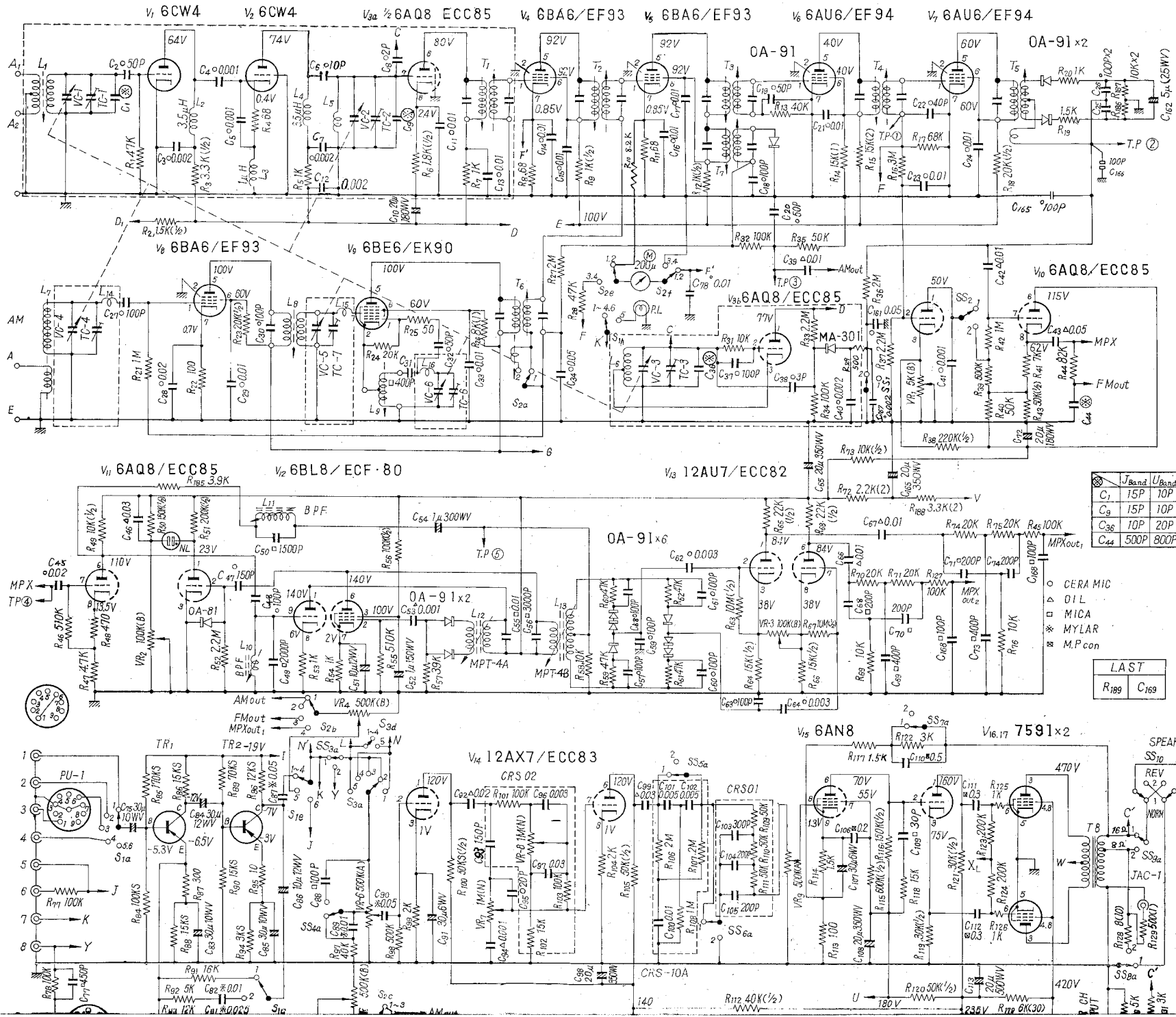

	J Band	U Band
C ₁	15P	10P
C ₉	15P	10P
C ₃₆	10P	20P
C ₄₄	500P	800P

○ CERA MIC
 △ OIL
 □ MICA
 * MYLAR
 ■ M.P.con

LAST
R ₁₈₉ C ₁₆₉

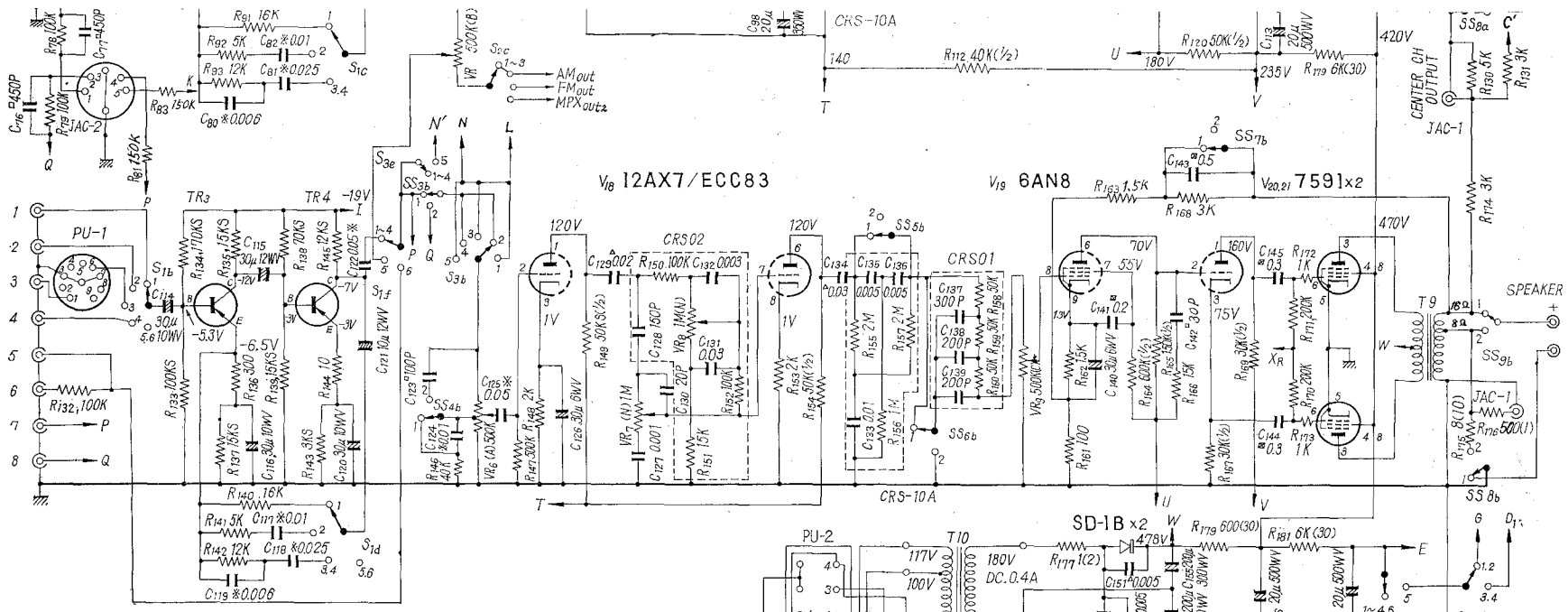

- | | | | |
|-------------|----------------------|----------------------|----------------------|
| 1 MIC | INPUT SELECTOR | BAND SELECTOR | MODE SELECTOR |
| 2 TAPE HEAD | S ₁ (a~h) | S ₂ (a~f) | S ₃ (a~e) |
| 3 PHONO-1 | 1 MIC → SET | 1 SHARP → SET | 1 STEREO REV |
| 4 PHONO-2 | 2 TAPE HEAD | 2 BROAD → AM | 2 STEREO NOR |
| 5 AUX-1 | 3 PHONO-1(Low Z) | 3 FM | → SET |
| 6 AUX-2 | 4 PHONO-2 | 4 FM-MPX | 3 MONO A |
| 7 REC | 5 TUNER | | 4 MONO B |
| 8 MONI | 6 AUX | | 5 MONO A+B |

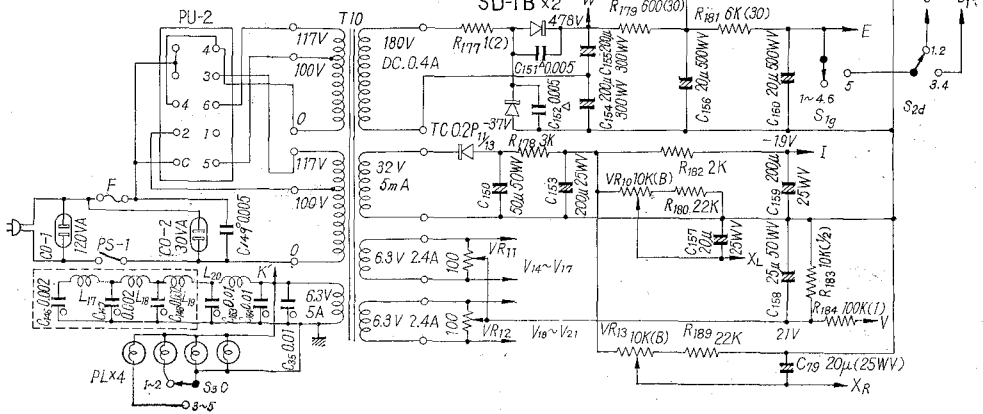

**MODEL
1000A** REMOVALS DISASSEMBLE
DIAL CORD STATINGS

DISASSEMBLE REMOVALS

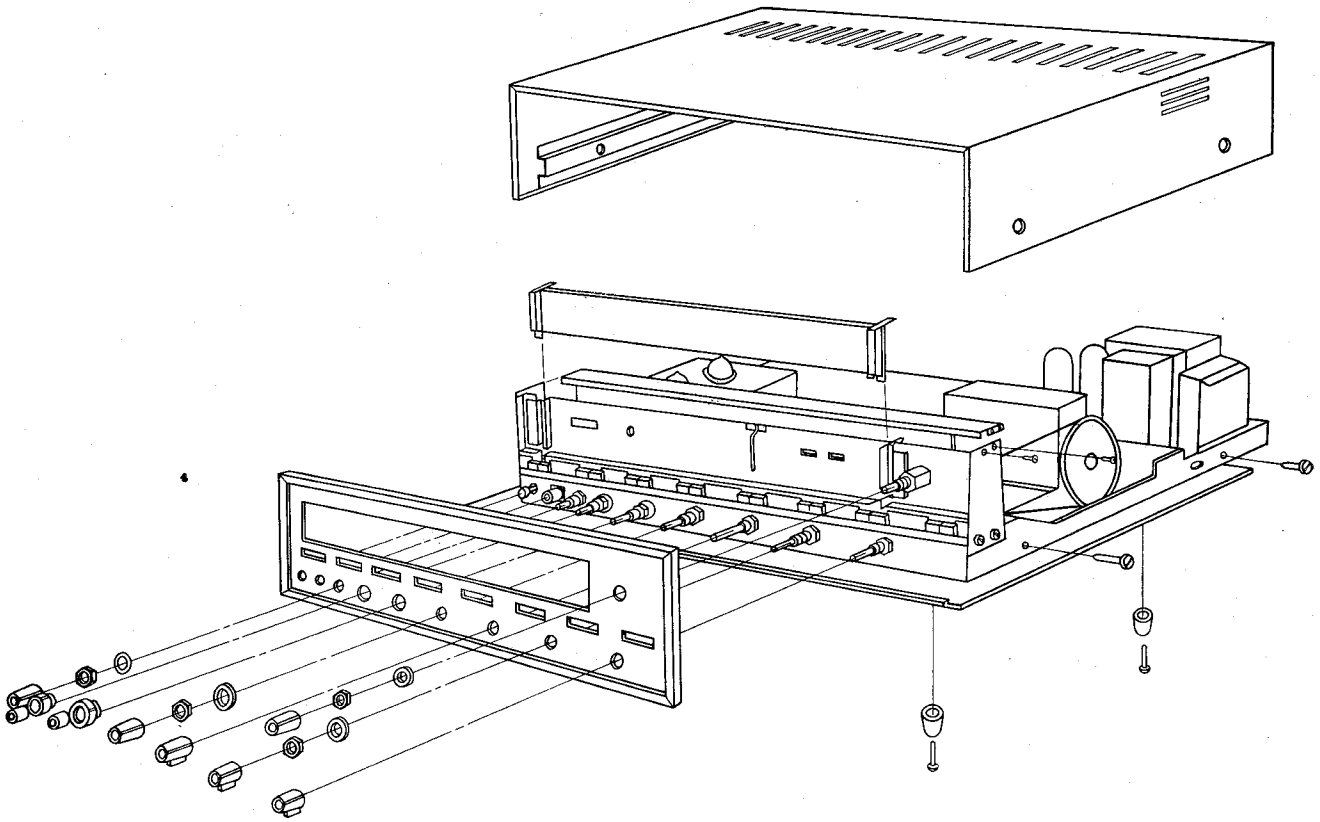

DIAL CORD STRINGS

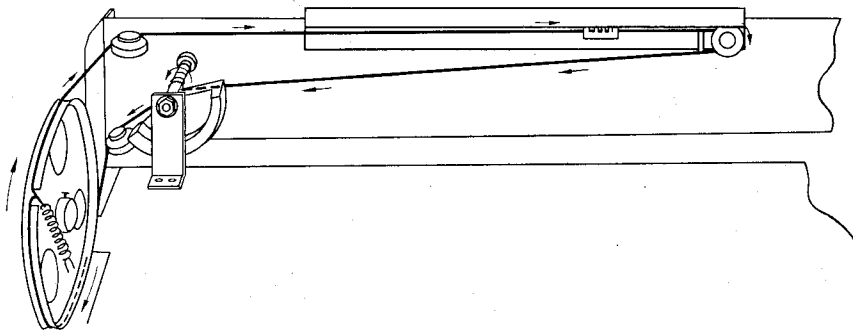

Sansui

SANSUI ELECTRIC COMPANY LIMITED

Head Office ; 460, Izumi-cho, Suginami-ku, Tokyo, Japan. TEL. 328-0111

Printed in Japan (36050M5)